

plaber®

 READY

HPRC READY MADE SOLUTIONS -- 2025

We are HPRC. We don't just design and manufacture watertight hard protective cases, we supply carrying solutions. And solutions need to be no-hassle and tailored to your needs.

This is why in Autumn 2013 we designed our first case with a foam specially cut to house the DJI Phantom 1.

Now, almost 12 years later, we are a leading manufacturer of custom cases for drones, gimbals, camcorders and cameras but we feel we are still at the beginning: more is yet to come.

MADE IN ITALY

## HPRC VECTOR PANEL

The new protective layer system designed for your Ready Case



Made of special PVC based compound, the Vector Panel ensures:

- foam long-last durability and integrity;
- improved protection for the equipment;
- dedicated item slots, suitably marked, avoiding lost tools;
- easy and quick organization of the case;
- savings in space and time;
- professional design and presentation.



The system significantly increases the overall performance and efficiency of the case in any kind of environment, weather conditions and temperature.



DJI

HPRC READY MADE SOLUTIONS — 2025



# HPRC2400 for DJI Mavic 3 Pro Cine Premium Combo / Fly More Combo

## S-MAV3P-2400-02

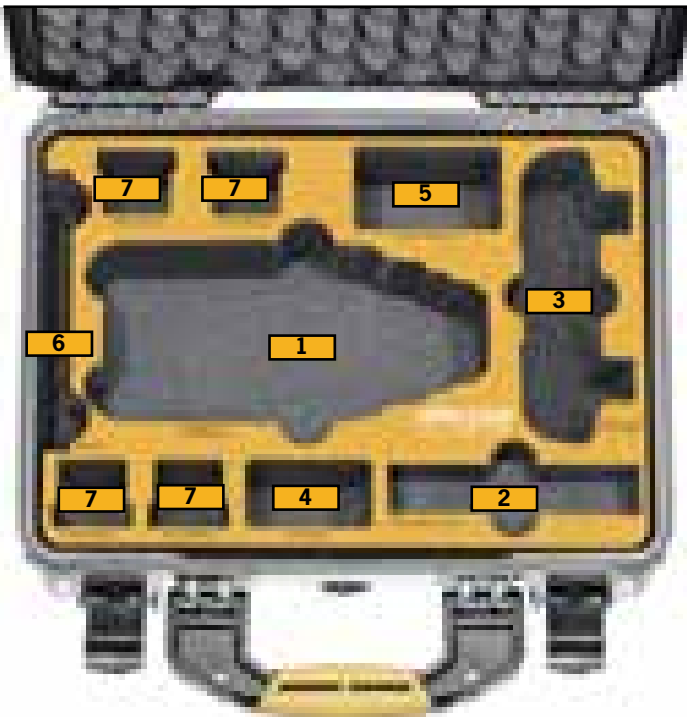

- 1** DJI Mavic 3 Pro Cine Premium Combo or Fly More Combo with Storage Cover
- 2** Battery Charging Hub / Cables
- 3** DJI RC Pro / DJI RC-N1 / DJI Smart Controller
- 4** Portable Charger DJI
- 5** Miscellaneous/Propellers for DJI Mavic 3 series
- 6** ND Filters Set
- 7** Intelligent Flight Battery



HPRC DJI MAVIC 3 PRO CINE PREMIUM COMBO / FLY MORE COMBO

### TECHNICAL FEATURES

**Dimension:**

Internal dimension:  
377x263,9x150,8(mm) - 14.84x10.39x5.94(in)

External dimension:  
402x330,5x169,2(mm) - 15.83x13.01x6.66(in)

**Weight:**

empty: 2,17kg - 4.78lbs  
with cubed foam: 2,58kg - 5.69lbs

**Temperature rating:**

Minimum            Maximum  
-40°C -40°F        +80°C +176°F



### TECHNICAL DRAWING

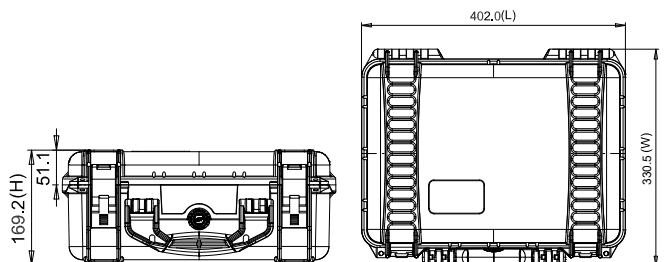

# HPRC2600 for DJI Mavic 3 Pro Cine Premium Combo Flying Mode & DJI Mini 4 Pro Fly More Combo **S-MAV3PFM-2600-01**

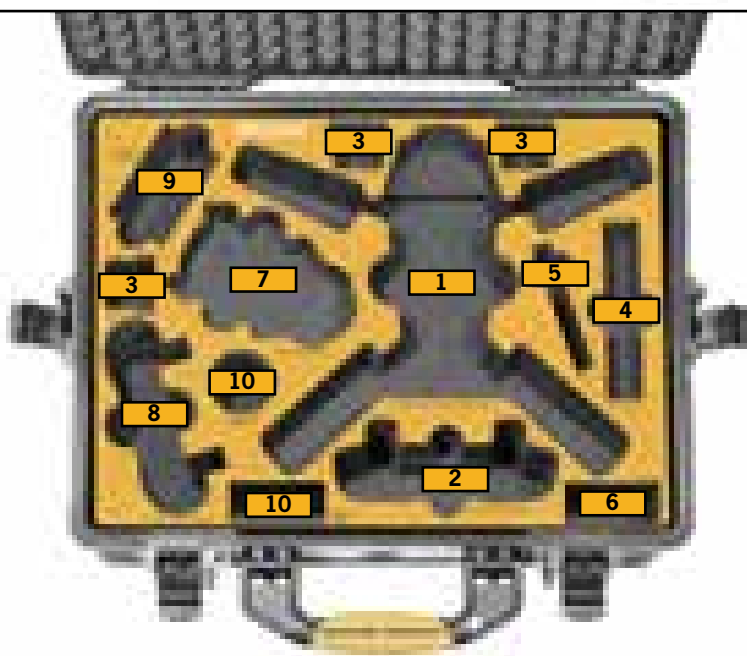
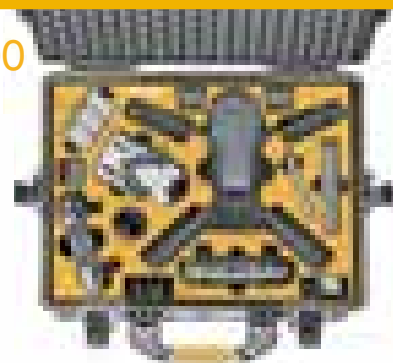

- 1** DJI Mavic 3 Pro Cine Premium Combo Flying Mode
- 2** DJI RC / Pro / DJI Smart Controller
- 3** Intelligent Flight Battery
- 4** Battery Charging Hub
- 5** ND Filters Set
- 6** Portable Charger
- 7** DJI Mini 4 Pro Fly More Combo
- 8** DJI RC2 / DJI RC-N2 Smart Controller
- 9** Mini 4 Pro Two-Way Charging Hub
- 10** Miscellaneous / Cables / Propellers



## TECHNICAL FEATURES

### Dimension:

Internal dimension:  
482,4x358,3x198,1(mm) - 18.99x14.10x7.80(in)

External dimension:  
543,4x426,8x218,1(mm) - 21.39x16.80x8.59(in)

### Weight:

empty: 4,25kg - 9.37lbs  
with cubed foam: 5,05kg - 11.13lbs

### Temperature rating:

Minimum            Maximum  
-40°C -40°F        +80°C +176°F

## TECHNICAL DRAWING

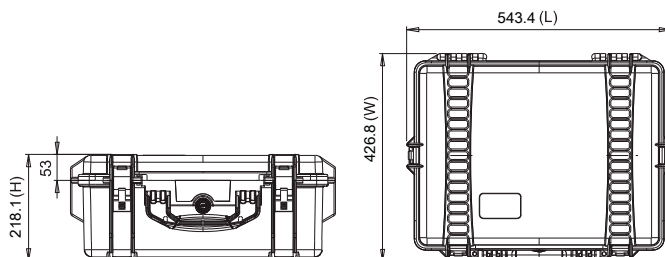

# HPRC3500 for DJI Mavic 3 Pro Cine Premium Combo / Fly More Combo

## S-MAV3P-3500-01



- 1** DJI Mavic 3 Pro with Storage Cover
- 2** Battery Charging Hub / Cables
- 3** DJI RC / Pro / DJI Smart Controller
- 4** Propellers / Portable Charger
- 5** Miscellaneous
- 6** ND Filters Set
- 7** Intelligent Flight Battery



HPRC DJI MAVIC 3 PRO CINE PREMIUM COMBO / FLY MORE COMBO

### TECHNICAL FEATURES

**Dimension:**  
 Internal dimension:  
 433,5x319,3x168,8(mm) - 17.07x12.57x6.65(in)  
 External dimension:  
 497,9x370,3x185(mm) - 19.60x14.58x7.28(in)

**Weight:**  
 empty: 3kg - 6.61lbs  
 with cubed foam: 3,55kg - 7.82lbs

**Temperature rating:**  
 Minimum      Maximum  
 -40°C -40°F      +80°C +176°F



### TECHNICAL DRAWING

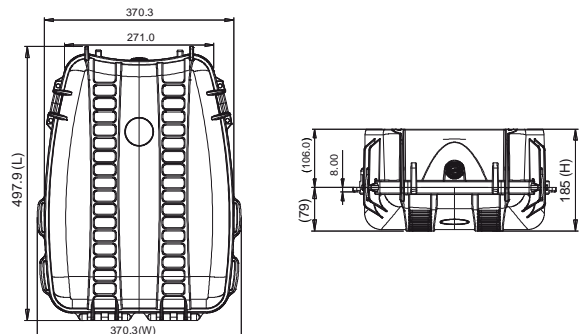

# HPRC Soft bag for DJI Mavic 3 Pro Cine Premium Combo / Fly More Combo

## S-MAV3PBAG35

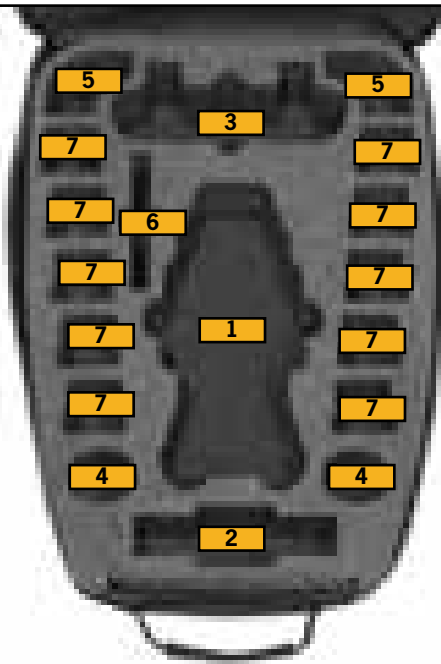

- 1** DJI Mavic 3 Pro with Storage Cover
- 2** Battery Charging Hub / Cables
- 3** DJI RC / Pro / DJI Smart Controller
- 4** Propellers / Portable Charger
- 5** Miscellaneous
- 6** ND Filters Set
- 7** Intelligent Flight Battery

### TECHNICAL FEATURES

**Dimension:**

internal dimension  
433x319x169(mm) - 17.05x12.56x6.65(in)  
external dimension  
498x370x185(mm) - 19.61x14.57x7.28(in)



# HPRC2400 for DJI Mavic 3 Cine / DJI Mavic 3 / DJI Mavic 3 Classic

## MAV3-2400-01



- 1** DJI Mavic 3 Cine / DJI Mavic 3 / DJI Mavic 3 Classic
- 2** Battery Charging Hub / Cables
- 3** DJI RC Pro / DJI RC-N1 / DJI Smart Controllers
- 4** Propellers / Portable Charger
- 5** Miscellaneous
- 6** ND Filters Set 2X
- 7** Intelligent Flight Battery



HPRC MAVIC 3 CINE / DJI MAVIC 3 / DJI MAVIC 3 CLASSIC

### TECHNICAL FEATURES

#### Dimension:

Internal dimension  
377x263,9x150,8(mm) - 14.84x10.39x5.94(in)  
External dimension  
402x330,5x169,2(mm) - 15.83x13.01x6.66(in)

#### Weight:

empty: 2,23kg - 4.92lbs  
with cubed foam: 2,58kg - 5.69lbs

#### Temperature rating:

Minimum Maximum  
-40°C -40°F +80°C +176°F



### TECHNICAL DRAWING

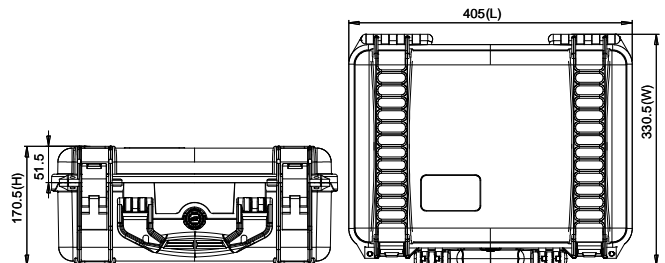

# HPRC3500 for DJI Mavic 3 Cine / DJI Mavic 3 / DJI Mavic 3 Classic

## MAV3-3500-01



- 1** DJI Mavic 3 Cine / DJI Mavic 3 / DJI Mavic 3 Classic
- 2** Battery Charging Hub / Cables
- 3** DJI RC Pro / DJI RC-N1 / DJI Smart Controllers
- 4** Propellers
- 5** Miscellaneous
- 6** ND Filters Set 2X
- 7** Intelligent Flight Battery



### TECHNICAL FEATURES

#### Dimension:

Internal dimension  
433,5x319,3x168,8(mm) - 17.07x12.57x6.65(in)  
External dimension  
497,9x370,3x184,9(mm) - 19.6x14.58x7.28(in)

#### Weight:

empty: 3,00kg - 6.61lbs  
with cubed foam: 3,55kg - 7.82lbs

#### Temperature rating:

Minimum Maximum  
-40°C -40°F +80°C +176°F



### TECHNICAL DRAWING

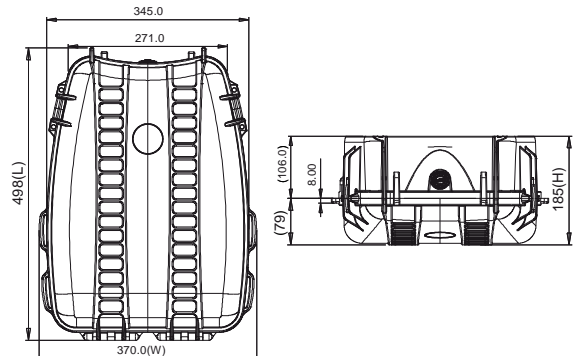

# HPRC Soft Bag for DJI Mavic 3 Cine / DJI Mavic 3

## MAVBAG35-05

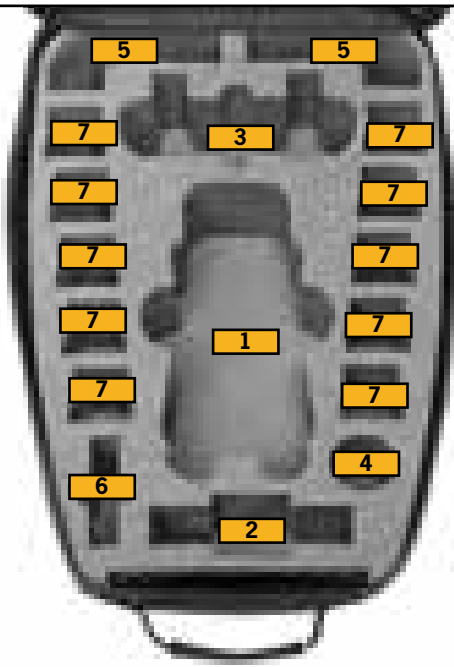

- 1** DJI Mavic 3 Cine / DJI Mavic 3
- 2** Battery Charging Hub / Cables
- 3** DJI RC Pro / DJI RC-N1 / DJI Smart Controllers
- 4** Propellers
- 5** Miscellaneous
- 6** ND Filters Set 2X
- 7** Intelligent Flight Battery



HPRC DJI MAVIC 3 / CINE

### TECHNICAL FEATURES

**Dimension:**  
 internal dimension  
 433x319x169(mm) - 17.05x12.56x6.65(in)  
 external dimension  
 498x370x185(mm) - 19.61x14.57x7.28(in)



# HPRC2800W for DJI Matrice 350 RTK (Zenmuse L2 & Zenmuse H30/H30T version) S-M350-2800W-03

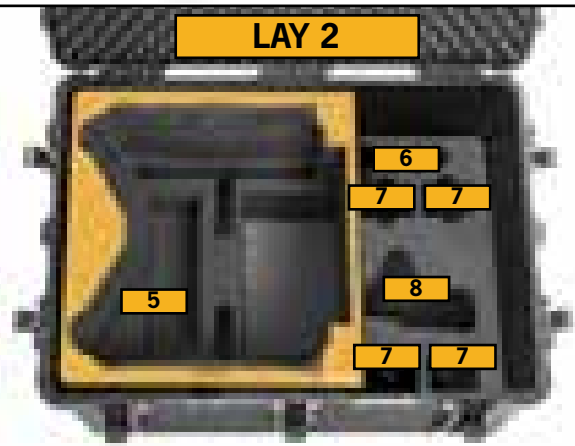
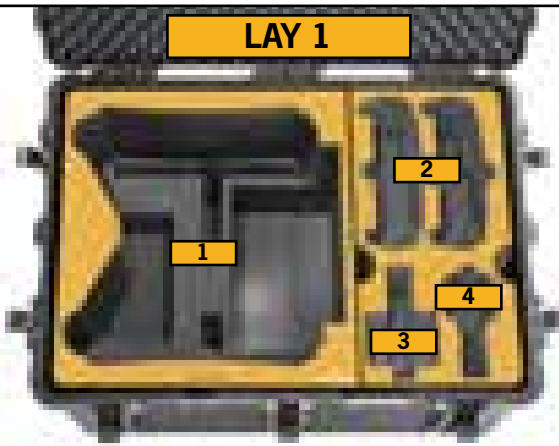
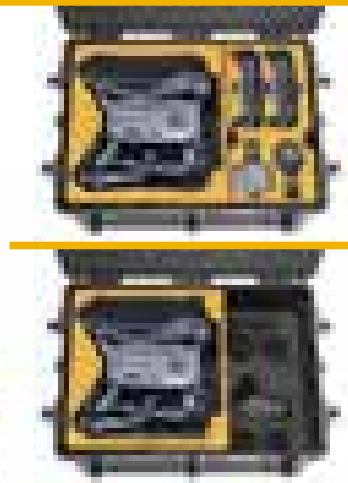

- 1** DJI Matrice 300 or 350 RTK in Landing Mode (2 Gimbal and 2 Batteries mounted)
- 2** 2X DJI RC Plus
- 3** Zenmuse L2
- 4** Zenmuse P1

- 5** Propellers
- 6** WB37 Intelligent Battery
- 7** TB60 or TB65 Intelligent Flight Battery
- 8** Zenmuse H30/H30T



HPRC DJI MATRICE 350 RTK

## TECHNICAL FEATURES

**Dimension:**  
 Internal dimension  
 748,6x524,6x454,6(mm) - 29.47x20.65x17.9(in)  
 External dimension  
 813,3x586,5x480,5(mm) - 32.02x23.09x18.92(in)

**Weight:**  
 empty: 13,25kg - 29.22lbs  
 with cubed foam: 17,43kg - 38.43lbs

**Temperature rating:**  
 Minimum Maximum  
 -40°C -40°F +80°C +176°F



## TECHNICAL DRAWING

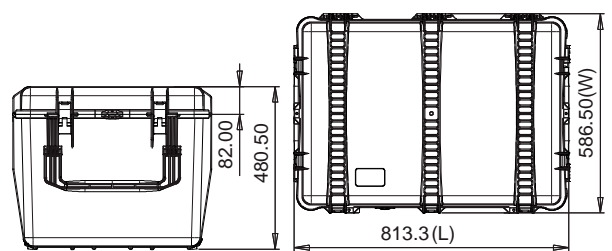



# HPRC2800W for DJI Matrice 300 RTK (Zenmuse H30/H30T version) S-M300-2800W-04

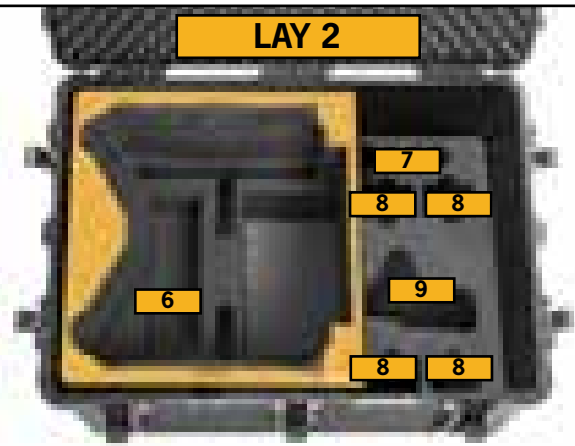
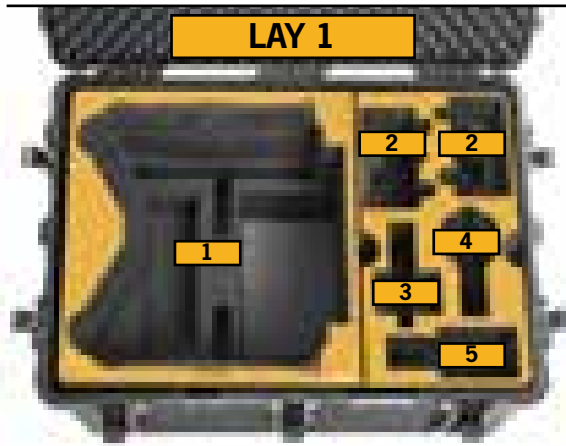
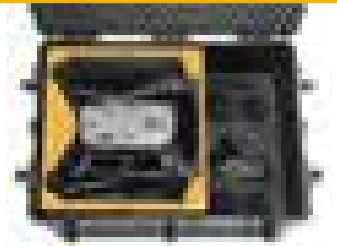
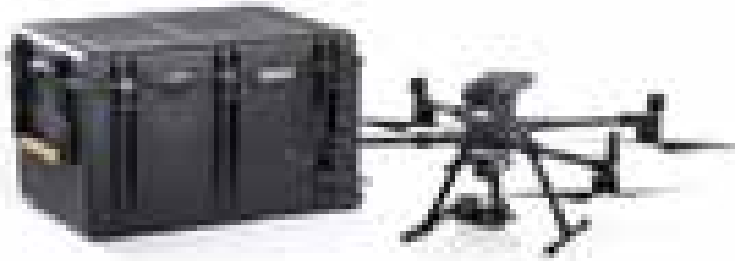

- 1** DJI Matrice 300 RTK in Landing Mode  
(2 Gimbal and 2 Batteries mounted)
- 2** DJI Smart Controller Enterprise (Battery Attached)
- 3** Zenmuse L1
- 4** Zenmuse P1
- 5** H20/H20T Gimbal

- 6** Propellers
- 7** WB37 Intelligent Battery
- 8** TB60 Intelligent Flight Battery
- 9** Zenmuse H30/H30T



HPRC DJI MATRICE 300 RTK

## TECHNICAL FEATURES

### Dimension:

Internal dimension  
748,6x524,6x454,6(mm) - 29.47x20.65x17.9(in)  
External dimension  
813,3x586,5x480,5(mm) - 32.02x23.09x18.92(in)



### Weight:

empty: 13,25kg - 29.22lbs  
with cubed foam: 17,43kg - 38.43lbs

### Temperature rating:

Minimum                      Maximum  
-40°C -40°F                      +80°C +176°F

## TECHNICAL DRAWING

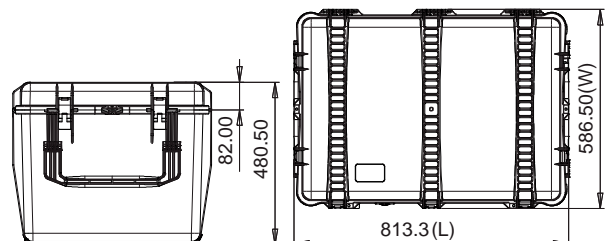

# HPRC2550W for Battery DJI Matrice 300/350 BAT2550W-04

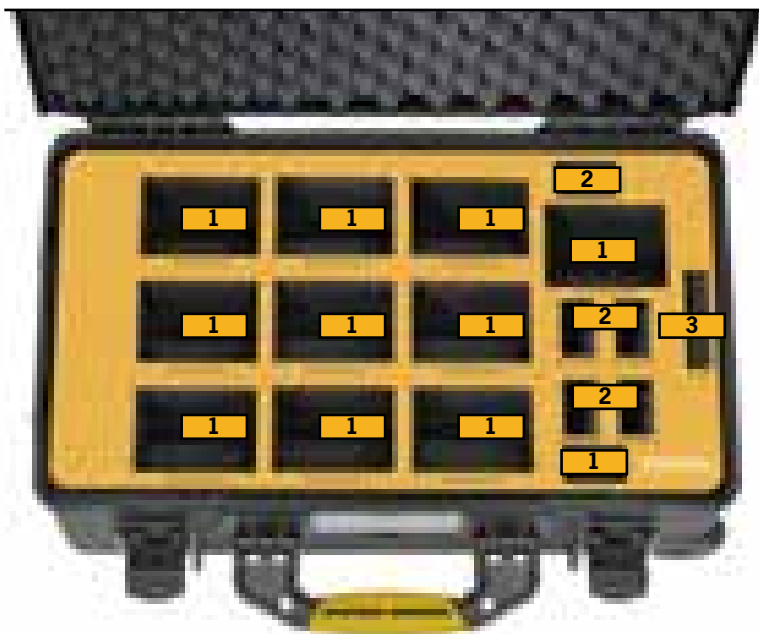
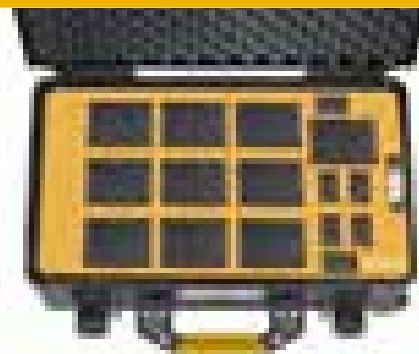

- 1** TB60/TB65 Intelligent Flight Battery
- 2** WB37 Intelligent Battery
- 3** Various/Perfect for Dry Keeper



HPRC M300/350 BATTERY CASE

## TECHNICAL FEATURES

### Dimension:

internal dimension  
513x288x200(mm) - 20.19x11.34x7.87(in)  
external dimension  
549x346x236(mm) - 21.61x13.62x9.29(in)

### Weight:

empty: 4.35kg - 9.57lbs

### Temperature rating:

Minimum Maximum  
-40°C -40°F +80°C +176°F



## TECHNICAL DRAWING

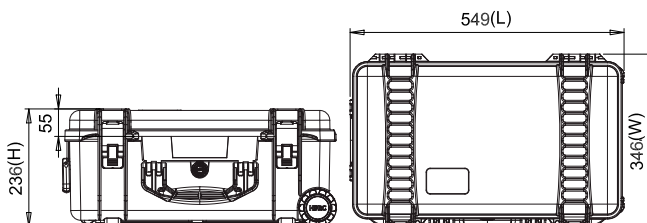

# HPRC6500W for DJI D-RTK 2

## DRTK6500W-01

**dji**  
D-RTK 2



- 1** D-RTK 2 Body
- 2** Accessories Box (Mobile Phone Holder; Charging Hub, Intelligent Battery, Battery Cover, Ac Power Adapter\Cable etc)
- 3** Extension Rod
- 4** Tripod

HPRC DJI D-RTK 2

### TECHNICAL FEATURES

**Dimension:**

Internal dimension  
1280,7x279x242,8(mm) - 50.42x10.98x9.56(in)  
External dimension  
1328x335x299,8(mm) - 52.28x13.19x11.8(in)

**Weight:**

empty: 7,2kg - 15.88lbs  
with cubed foam: 9,03kg - 19.90lbs

**Temperature rating:**

Minimum Maximum  
-40°C -40°F +80°C +176°F



### TECHNICAL DRAWING

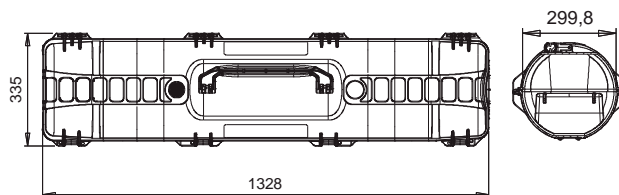

# HPRC2710 for DJI Matrice 3D/3TD

## S-M3TD-2710-01

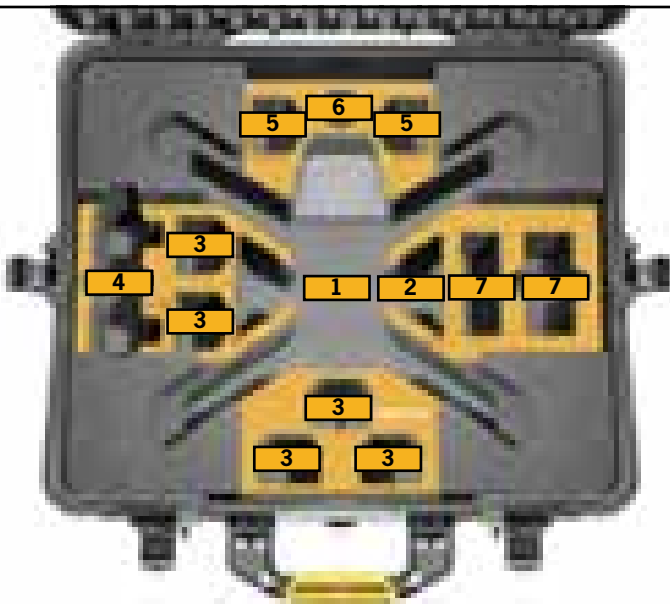

- 1** DJI Matrice 3D/3TD
- 2** Miscellaneous/Cables
- 3** Batteries
- 4** DJI RC Pro/DJI RC-N1/DJI Smart Controllers
- 5** Miscellaneous/Cables/Batteries
- 6** Propellers
- 7** Charging Kit



HPRC DJI MATRICE 3D/3TD

### TECHNICAL FEATURES

**Dimension:**

Internal dimension  
555x459x256(mm) - 21.85x18.07x10.08(in)

External dimension:  
617x525x280(mm) - 24.29x20.67x11.02(in)

**Weight:**

empty: 6,56kg - 14.46lbs  
with cubed foam: 7,96kg - 17.55lbs

**Temperature rating:**

Minimum	Maximum
-40°C -40°F	+80°C +176°F

### TECHNICAL DRAWING

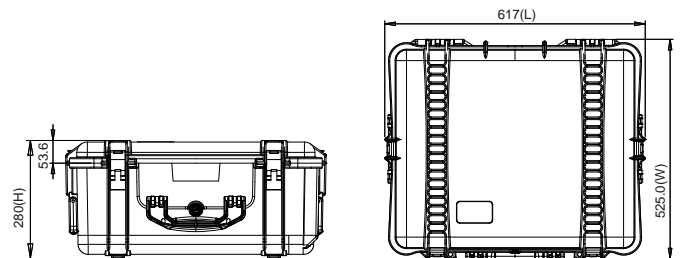

# HPRC5200R for DJI Matrice 30T

## M30T-5200R-01

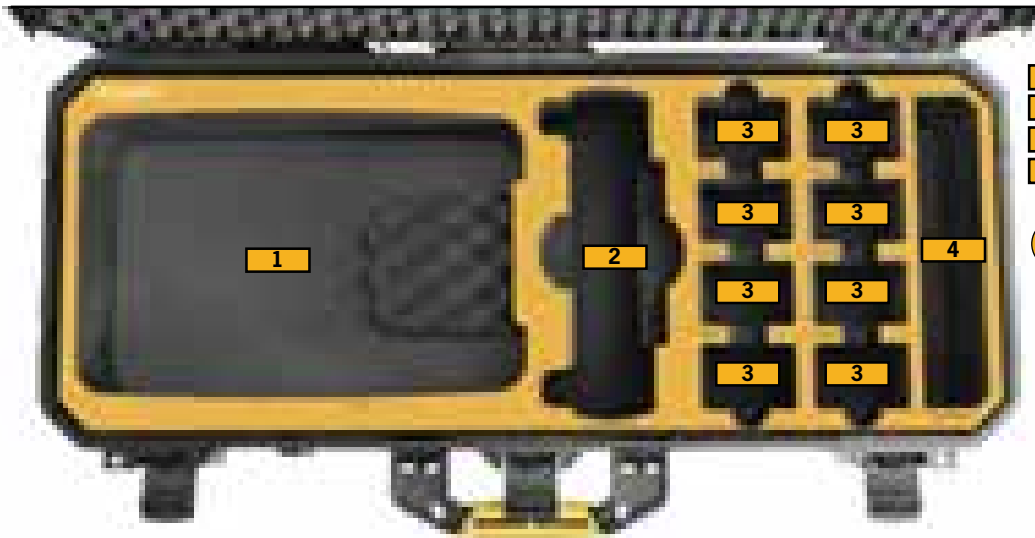
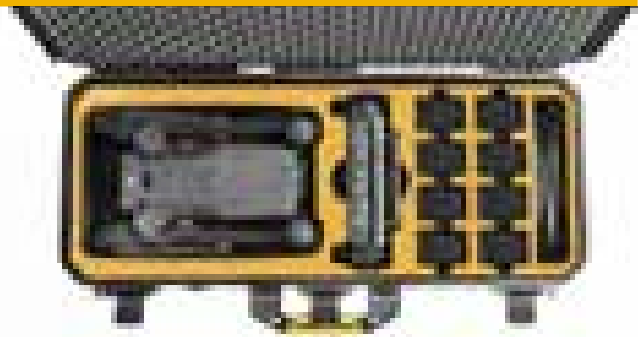

- 1** Aircraft Body
- 2** DJI RC Plus Remote Controller
- 3** TB30 Battery
- 4** Various/Miscellaneous



### TECHNICAL FEATURES

**Dimension:**

Internal dimension  
772x302x210(mm) - 30.39x11.89x8.26 (in)  
External dimension  
802x355x246.7(mm) - 31.57x13.97x9,71 (in)

**Weight:**

empty: 5.05kg – 11.1lbs

**Temperature rating:**

Minimum            Maximum  
-40°C -40°F        +80°C +176°F

### TECHNICAL DRAWING

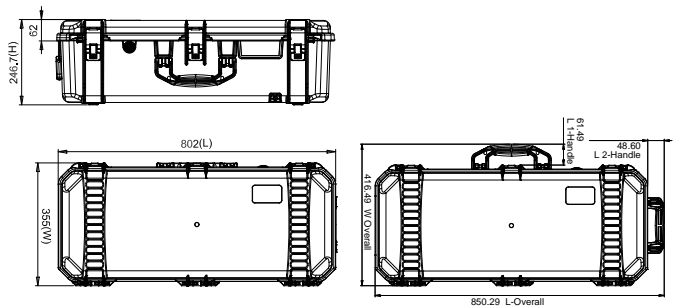

# HPRC2760W for DJI Matrice 30T

## M30T-2760W-01

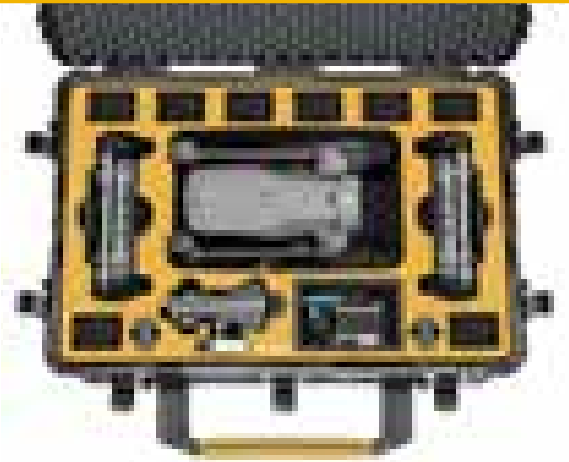

- 1** WB37 Battery
- 2** TB30 Battery
- 3** DJI RC Plus Remote Controller
- 4** Aircraft Body
- 5** Loudspeaker
- 6** Miscellaneous



HPRC DJI MATRICE 30T

### TECHNICAL FEATURES

**Dimension:**

Internal dimension  
690x450x301(mm) - 27.16x17.72x11.85(in)  
External dimension  
750x511x329(mm) - 29.53x20.12x12.95(in)

**Weight:**

empty: 8,93kg - 19.69lbs  
with cubed foam: 10,72kg - 23.63lbs

**Temperature rating:**

Minimum	Maximum
-40°C -40°F	+80°C +176°F



### TECHNICAL DRAWING

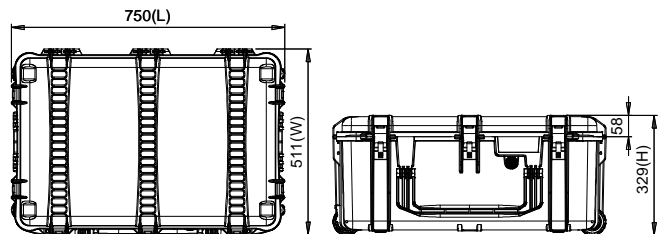

# HPRC2700W for DJI Matrice 30T

## M30T-2700W-01



- 1** Aircraft Body
- 2** Various/Miscellaneous
- 3** DJI RC Plus Remote Controller
- 4** Various/Miscellaneous
- 5** TB30 Battery



### TECHNICAL FEATURES

#### Dimension:

Internal dimension  
554,7x458,7x246(mm) - 21.84x18.06x9.69(in)  
External dimension  
617,5x527,3x279,6(mm) - 24.31x20.76x11.0(in)

#### Weight:

empty: 7,75kg - 17.09lbs  
with cubed foam: 9,07kg - 19.99lbs

#### Temperature rating:

Minimum            Maximum  
-40°C -40°F        +80°C +176°F



### TECHNICAL DRAWING

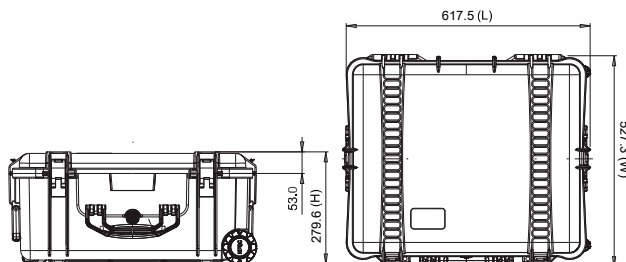

# HPRC2460 for Batteries TB30 and DJI RC Plus BAT2460-01



- 1** DJI RC Plus Remote Controller
- 2** WB37 Battery
- 3** TB30 Battery



HPRC M30T BATTERY CASE

## TECHNICAL FEATURES

### Dimension:

Internal dimension  
409x306x175(mm) - 16.10x12.05x6.89(in)  
External dimension  
435x377,8x193(mm) - 17.13x14.87x7.60(in)

### Weight:

empty: 2,55kg - 5.62lbs  
with foam: 3,14kg - 6.92lbs

### Temperature rating:

Minimum	Maximum
-40°C -40°F	+80°C +176°F



## TECHNICAL DRAWING

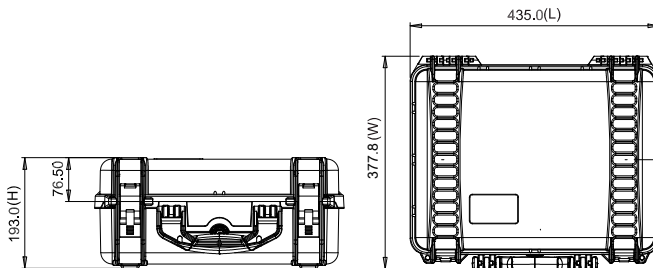



# HPRC2500 for DJI RC Plus Controllers and WB37 Batteries

## S-RCP-2500-01

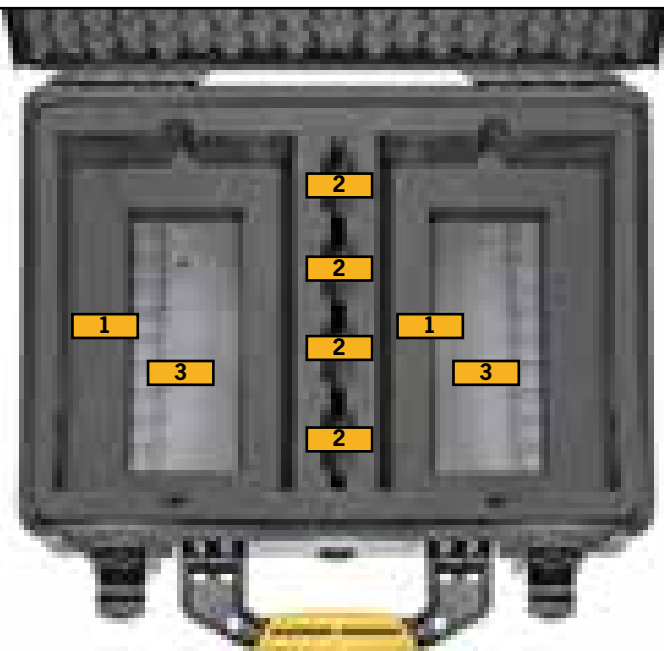
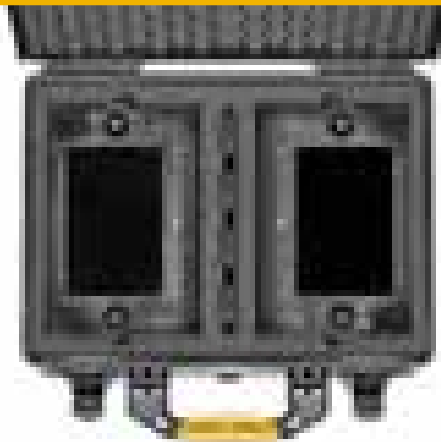

- 1** DJI RC Plus Controllers
- 2** WB37 Batteries
- 3** Miscellaneous

HPRC DJI RC PLUS CONTROLLERS

### TECHNICAL FEATURES

**Dimension:**

Internal dimension:  
449,8x322,9x174,9(mm) - 17.71x12.71x6.89(in)  
External dimension:  
478,1x389,4x194(mm) - 18.82x15.33x7.64(in)

**Weight:**

empty: 3,08kg - 6.79lbs  
with cubed foam: 3,71kg - 8.18lbs

**Temperature rating:**

Minimum Maximum  
-40°C -40°F +80°C +176°F



### TECHNICAL DRAWING

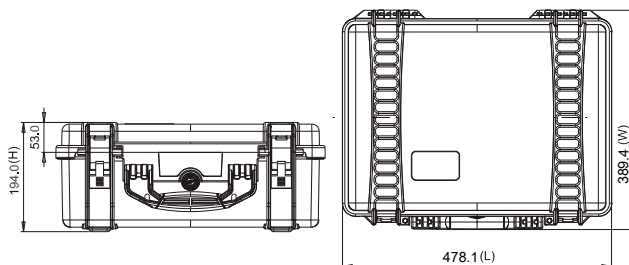

# HPRC2800W for DJI Inspire 3

## S-INS3-2800W-01

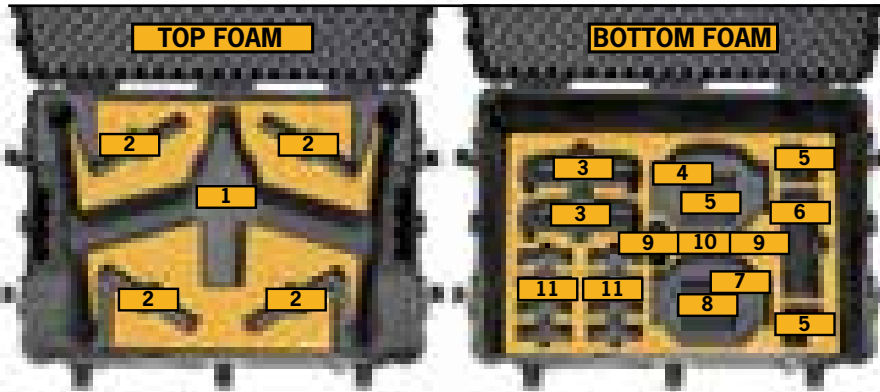
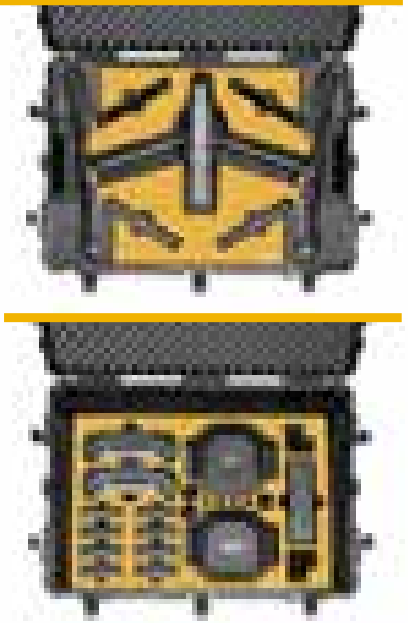
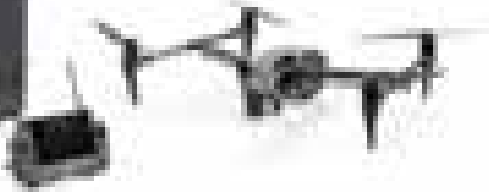

- 1** 1 Inspire 3 Aircraft
- 2** Foldable Quick-Release Propellers (Pair)/ Miscellaneous
- 3** RC Plus
- 4** Zenmuse X9-8K Air Gimbal Camera Case
- 5** Various / Miscellaneous
- 6** TB51 Intelligent Battery Charging Hub
- 7** Lens Carrying Box (18/24/35/50mm)
- 8** RC Plus Strap
- 9** Cable
- 10** PROSSD 1TB
- 11** TB51 Intelligent Battery



HPRC DJI INSPIRE 3

### TECHNICAL FEATURES

**Dimension:**

Internal dimension:  
748,6x524,6x454,6(mm) - 29.47x20.65x17.90(in)

External dimension:  
813,3x586,5x480,5(mm) - 32.02x23.09x18.92(in)

**Weight:**

empty: 13,25kg - 29.22lbs  
with cubed foam: 17,43kg - 38.43lbs

**Temperature rating:**

Minimum                      Maximum  
-40°C -40°F                      +80°C +176°F



### TECHNICAL DRAWING

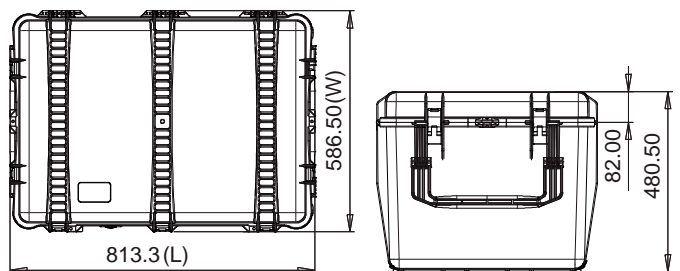

# HPRC2550W for Inspire 3 batteries

## S-BAT2550W-05

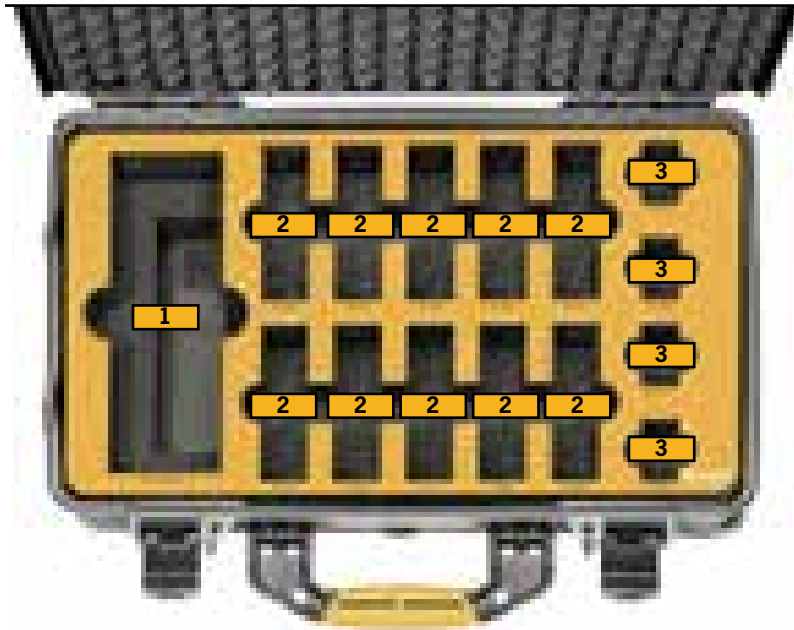
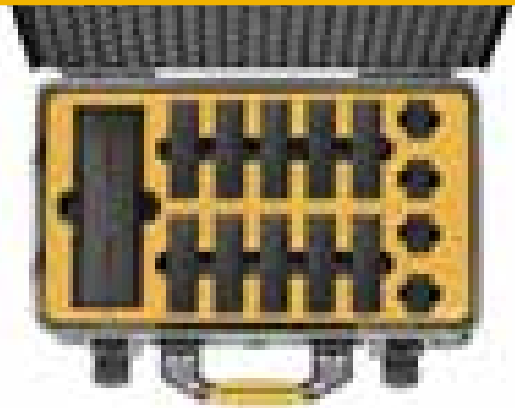

- 1** Charging Hub Inspire 3
- 2** TB51 Battery
- 3** WB37 Battery



HPRC INSPIRE 3 BATTERY CASE

### TECHNICAL FEATURES

**Dimension:**

internal dimension  
513x288x200(mm) - 20.19x11.34x7.87(in)  
external dimension  
549x346x236(mm) - 21.61x13.62x9.29(in)

**Weight:**

empty: 4,35kg - 9.57lbs  
with cubed foam: 5,04kg - 11.10lbs

**Temperature rating:**

Minimum Maximum  
-40°C -40°F +80°C +176°F



### TECHNICAL DRAWING

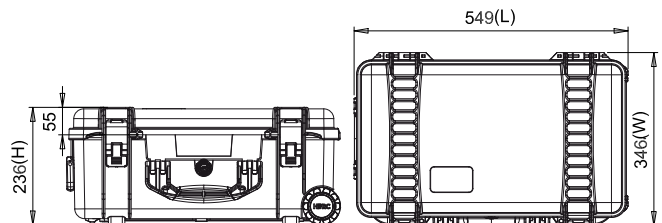

# HPRC2300 for DJI Mini 4 Pro Fly More Combo with Smart Controller **S-MAVM-2300-04**



- 1** DJI Mini 4 Pro Fly More Combo
- 2** Spare Propellers/Cables
- 3** Flight Batteries
- 4** Smart Controller
- 5** Two-Way Charging Hub
- 6** Intelligent Flight Battery
- 7** Miscellaneous



HPRC DJI MINI 4 PRO

## TECHNICAL FEATURES

### Dimension:

Internal dimension:  
305,7x232,4x137,5(mm) - 12.04x9.15x5.41(in)  
External dimension:  
334,6x303x155,2(mm) - 13.17x11.93x6.11(in)

### Weight:

empty: 1,75kg - 3.86lbs  
with cubed foam: 1,90kg - 4.19lbs

### Temperature rating:

Minimum Maximum  
-40°C -40°F +80°C +176°F



## TECHNICAL DRAWING

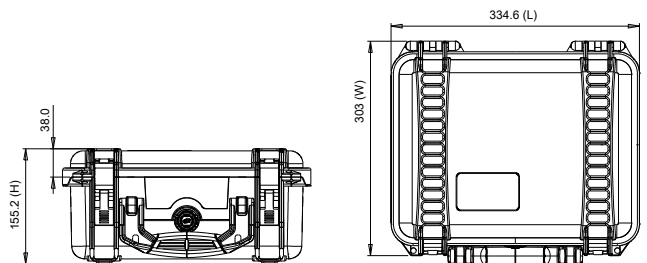

# HPRC2300 for Dji Neo Fly More Combo

## S-NEO-2300-01

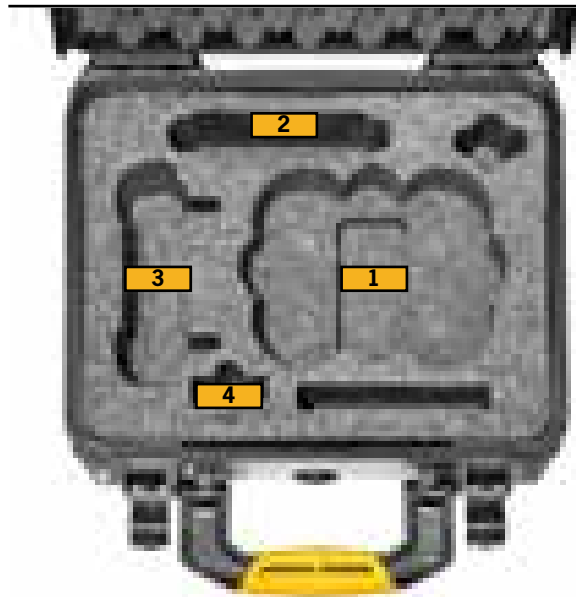

- 1** DJI Neo
- 2** Two-Way Charging Hub with Intelligent Flight Battery
- 3** DJI RC-N3 Remote Controller
- 4** Cables & Propellers

Foam in Arplank 30: 100% recyclable and manufactured with 25% recycled content

### TECHNICAL FEATURES

**Dimension:**

Internal dimension  
305,7x232,4x137,5(mm) - 12.04x9.15x5.41 (in)  
External dimension  
334,6x303x155,2(mm) - 13.17x11.93x6.11(in)

**Weight:**

empty: 1,75kg - 3.86lbs

**Temperature rating:**

Minimum	Maximum
-40°C -40°F	+80°C +176°F



### TECHNICAL DRAWING

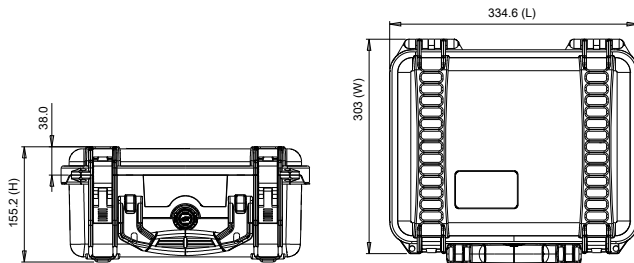



# HPRC2400 for DJI Air 3 & Air 3S Fly More Combo

## S-MAV3A-2400-02

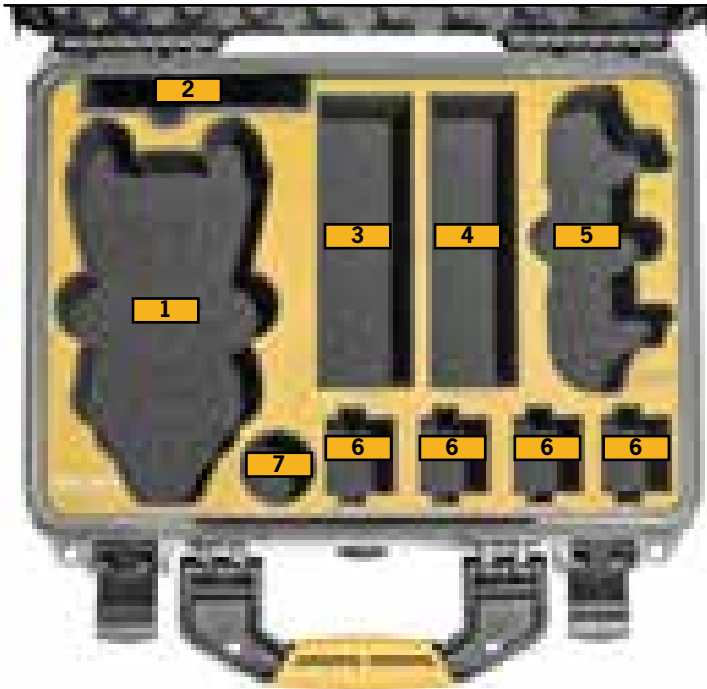
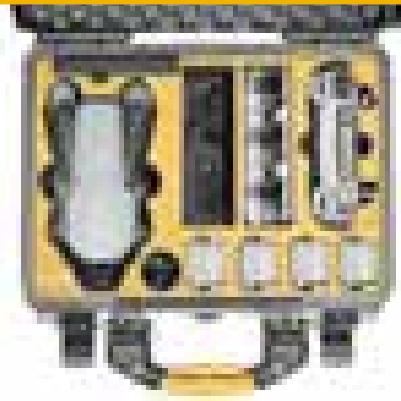

- 1** DJI Air 3 & Air 3S with Gimbal Protector
- 2** ND Filters Set
- 3** Miscellaneous
- 4** Battery Charging Hub
- 5** DJI RC 2 / DJI RC-N2 or DJI RC-N3
- 6** Intelligent Flight Battery
- 7** Cables



HPRC DJI AIR 3 & AIR 3S FLY MORE COMBO

### TECHNICAL FEATURES

**Dimension:**

Internal dimension:  
377x263,9x150,8(mm) - 14.84x10.39x5.94(in)

External dimension:  
402x330,5x169,2(mm) - 15.83x13.01x6.66(in)

**Weight:**

empty: 2,17kg - 4.78lbs  
with cubed foam: 2,58kg - 5.69lbs

**Temperature rating:**

Minimum            Maximum  
-40°C -40°F        +80°C +176°F



### TECHNICAL DRAWING

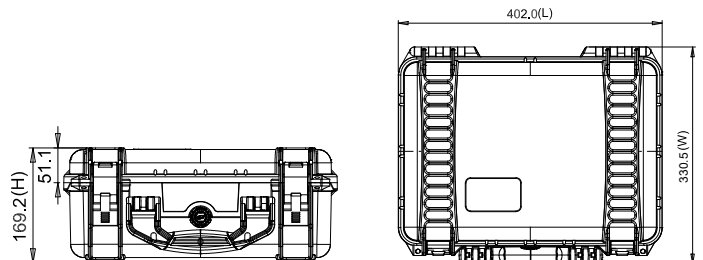

# HPRC3500 DJI Air 3 & Air 3S Fly More Combo

## S-MAV3A-3500-01

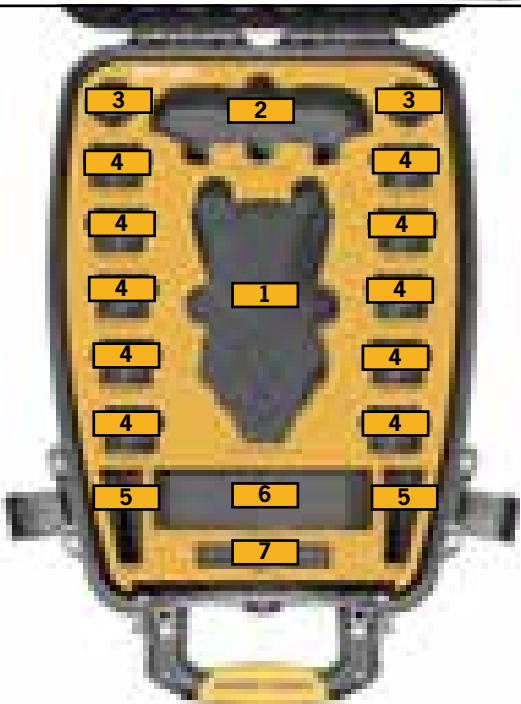
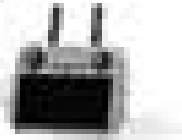

- 1** DJI Air 3 & Air 3S with Gimbal Protector
- 2** DJI RC 2 / DJI RC-N2 or DJI RC-N3
- 3** Cables
- 4** Intelligent Flight Battery
- 5** Propellers
- 6** Battery Charging Hub
- 7** ND Filters Set



HPRC DJI AIR 3 & AIR 3S FLY MORE COMBO

### TECHNICAL FEATURES

**Dimension:**  
 Internal dimension:  
 433,5x319,3x168,8(mm) - 17.07x12.57x6.65(in)  
 External dimension:  
 497,9x370,3x185(mm) - 19.60x14.58x7.28(in)

**Weight:**  
 empty: 3kg - 6.61lbs  
 with cubed foam: 3,55kg - 7.82lbs

**Temperature rating:**  
 Minimum      Maximum  
 -40°C -40°F      +80°C +176°F



### TECHNICAL DRAWING

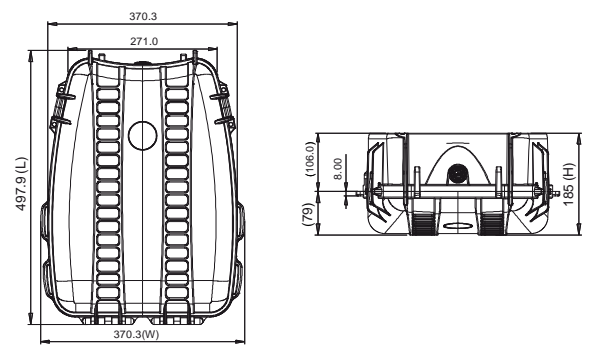



# HPRC2500 for DJI Avata 2 Fly More Combo

## S-AVAT2-2500-01

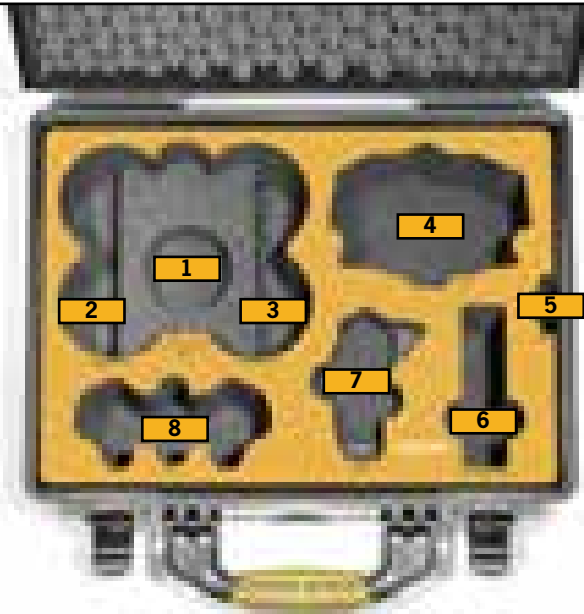

- 1** DJI Avata 2 Fly More Combo
- 2** Miscellaneous/ Cables
- 3** Propellers
- 4** Goggles 3
- 5** ND Filters
- 6** Two-Way Charging Hub with Batteries
- 7** RC Motion 3
- 8** Controller



HPRC DJI AVATA 2 FLY MORE COMBO

### TECHNICAL FEATURES

#### Dimension:

Internal dimension:  
449,8x322,9x174,9(mm) - 17.71x12.71x6.89(in)

External dimension:  
478,1x389,4x194(mm) - 18.82x15.33x7.64(in)

#### Weight:

empty: 3,08kg - 6.79lbs  
with cubed foam: 3,71kg - 8.18lbs

#### Temperature rating:

Minimum            Maximum  
-40°C -40°F        +80°C +176°F



### TECHNICAL DRAWING

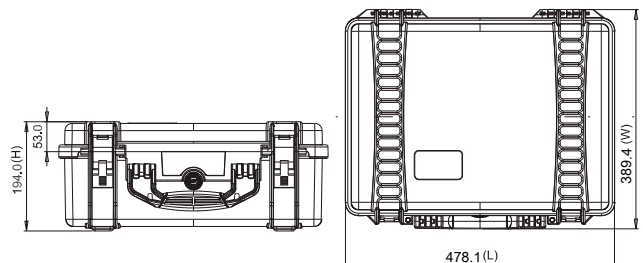

# HPRC3500 for DJI Avata 2 Fly More Combo

## S-AVAT2-3500-01

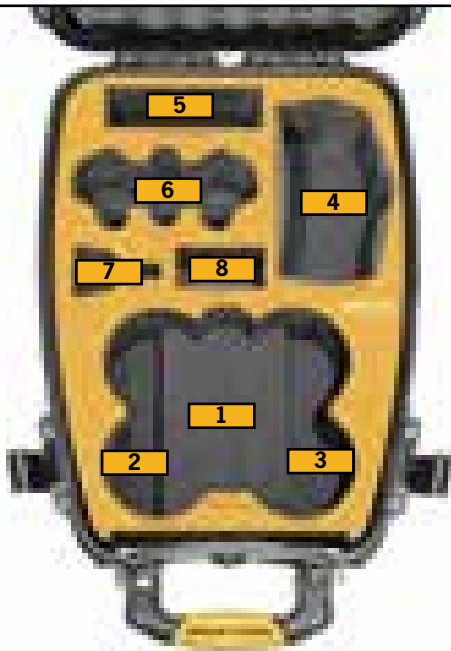

- 1** DJI Avata 2 Fly More Combo
- 2** Miscellaneous/ Cables
- 3** ND Filters / Cables
- 4** Goggles 3
- 5** Two-Way Charging Hub with Batteries
- 6** Controller
- 7** RC Motion 3
- 8** Propellers



HPRC DJI AVATA 2 FLY MORE COMBO

### TECHNICAL FEATURES

#### Dimension:

Internal dimension:  
433,5x319,3x168,8(mm) - 17.07x12.57x6.65(in)

External dimension:  
497,9x370,3x185(mm) - 19.6x14.58x7.28(in)

#### Weight:

empty: 3,00kg - 6.61lbs  
with cubed foam: 3,55kg - 7.82lbs

#### Temperature rating:

Minimum                      Maximum  
-40°C -40°F                      +80°C +176°F



### TECHNICAL DRAWING

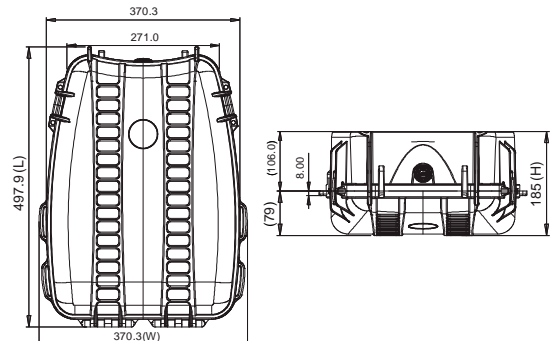

# HPRC2500 for DJI Avata Pro - View Combo

## AVAT-2500-01

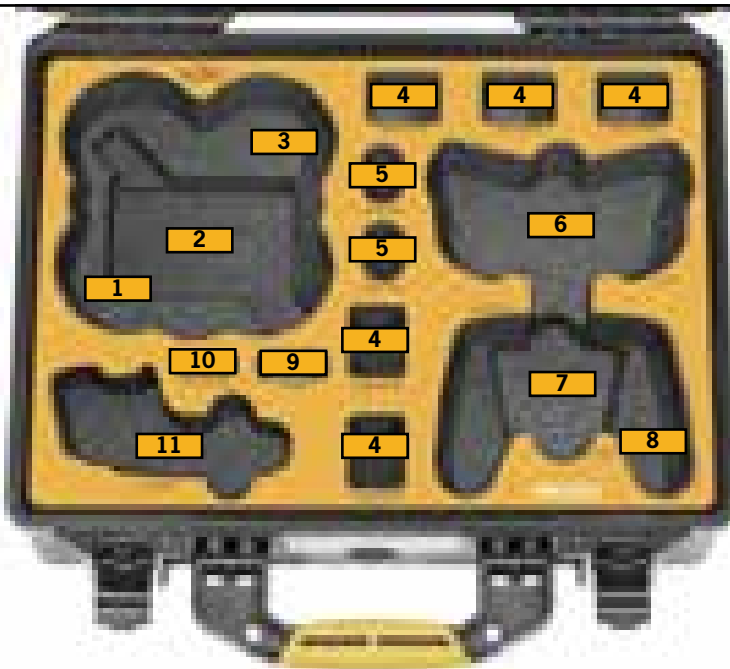

- 1** DJI Avata
- 2** Battery Charging Hub
- 3** Cable/Miscellaneous
- 4** Intelligent Flight Battery
- 5** Goggles 2 Battery
- 6** Goggles 2
- 7** Cable/Miscellaneous
- 8** Controller
- 9** Power Adapter
- 10** Eyeglass Frames (Pair)
- 11** Motion Controller



HPRC DJI AVATA PRO

### TECHNICAL FEATURES

**Dimension:**

Internal dimension:  
449,8x322,9x174,9(mm) - 17.71x12.71x6.89(in)  
External dimension:  
478,1x389,4x194,0(mm) - 18.82x15.33x7.64(in)

**Weight:**

empty: 3,08kg - 6.79lbs  
with cubed foam: 3,71kg - 8.18lbs

**Temperature rating:**

Minimum	Maximum
-40°C -40°F	+80°C +176°F



### TECHNICAL DRAWING

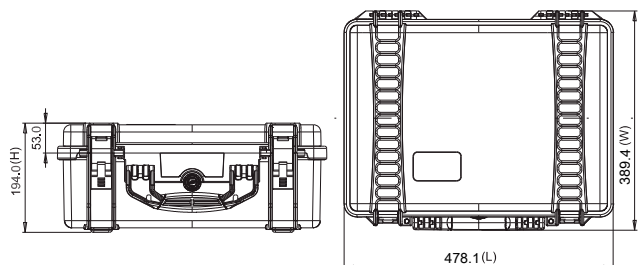

# HPRC3500 for DJI Avata Pro - View Combo

## AVAT-3500-01



- 1** DJI Avata
- 2** Cable/Miscellaneous
- 3** Battery Charging Hub
- 4** Goggles 2
- 5** Intelligent Flight Battery
- 6** Eyeglass Frames (Pair)
- 7** Controller
- 8** Cable/Miscellaneous
- 9** Power Adapter
- 10** Goggles 2 Battery
- 11** Motion Controller



HPRC DJI AVATA PRO

### TECHNICAL FEATURES

**Dimension:**

Internal dimension:  
433,5x319,3x168,8(mm) - 17.07x12.57x6.65(in)  
External dimension:  
497,9x370,3x184,9(mm) - 19.6x14.58x7.28(in)

**Weight:**

empty: 3,00kg - 6.61lbs  
with cubed foam: 3,55kg - 7.82lbs

**Temperature rating:**

Minimum	Maximum
-40°C -40°F	+80°C +176°F



### TECHNICAL DRAWING

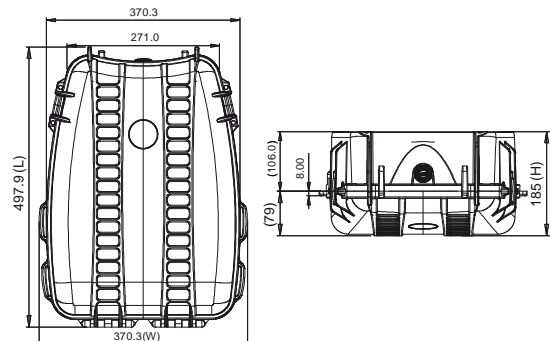

# HPRC2500 for DJI FPV Combo

## FPV-2500-01



- 1** DJI FPV Drone
- 2** Goggles Battery
- 3** Fly More kit
- 4** Goggles V2 with Goggles Antenna (or TrueRC) mounted
- 5** Remote Controller
- 6** Motion Controller
- 7** AC Power Adaptor
- 8** Intelligent Flight Battery
- 9** Propellers (Pair)/Cable



HPRC DJI FPV

### TECHNICAL FEATURES

#### Dimension:

internal dimension  
449,8x322,9x174,9(mm) - 17.71x12.71x6.89(in)  
external dimension  
478,1x389,4x194(mm) - 18.82x15.33x7.64(in)

#### Weight:

empty: 3,22kg - 7.10lbs  
with cubed foam: 3,69kg - 8.12lbs

#### Temperature rating:

Minimum            Maximum  
-40°C -40°F        +80°C +176°F



### TECHNICAL DRAWING

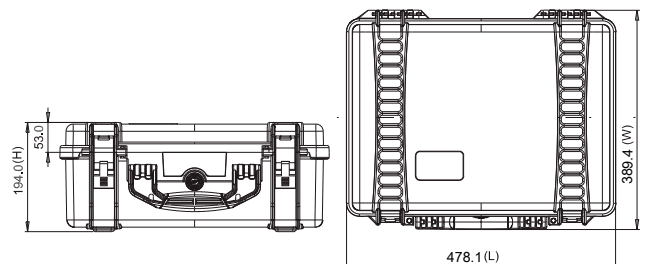

# HPRC3600 for DJI FPV Combo

## FPV-3600-01

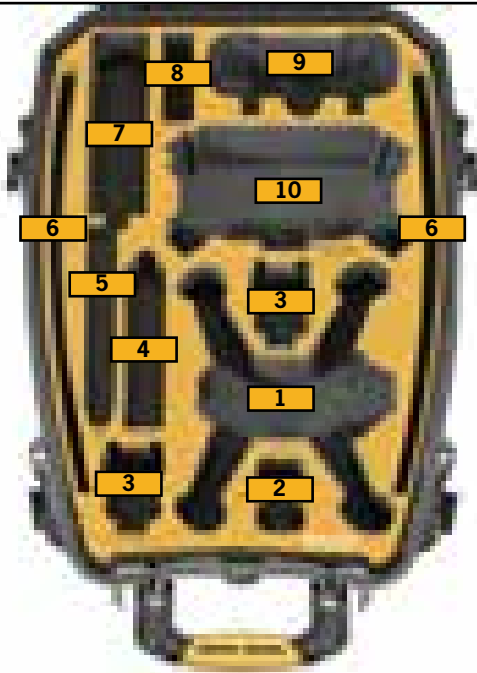

- 1** DJI FPV Drone
- 2** Goggles Battery
- 3** Intelligent Flight Battery
- 4** AC Power Adaptor
- 5** Fly More kit
- 6** Propellers (Pair)/Cable
- 7** Miscellaneous/Motion Controller
- 8** Miscellaneous
- 9** Remote Controller
- 10** Goggles V2 with Goggles Antenna (or TrueRC) mounted



HPRC DJI FPV

### TECHNICAL FEATURES

**Dimension:**

Internal dimension  
479x354x194(mm) - 18.86x13.94x7.64(in)  
External dimension  
542x402x220(mm) - 21.34x15.83x8.66(in)

**Weight:**

empty: 3,23 kg - 7,11 lbs  
with foam: 3,75 kg - 8,26 lbs

**Temperature rating:**

Minimum	Maximum
-40°C -40°F	+80°C +176°F

### TECHNICAL DRAWING

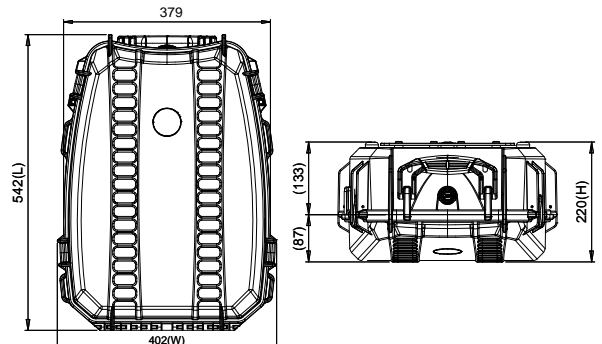

# HPRC2700W for DJI Phantom 4RTK PHA4RTK-2700W-01



- 1** Dji Phantom 4 RTK / Multispectral
- 2** Intelligent Flight Battery
- 3** Remote Controller
- 4** Ipad Air/Tablet Up to 10"
- 5** Hprc1100 For 8 Microsd Cards
- 6** Charging Hub for WB37
- 7** Battery WB37
- 8** Charging Hub for Int.flight Battery
- 9** AC Power Adapter / Miscellaneous Accessories
- 10** Propellers



suitable for v 2.0 low noise propellers

## TECHNICAL FEATURES

### Dimension:

Internal dimension  
554,7x458,7x246(mm) - 21.84x18.06x9.69(in)  
External dimension  
617,5x527,3x279,6(mm) - 24.31x20.76x11.0(in)

### Weight:

empty: 7,75kg - 17.09lbs  
with cubed foam: 9,07kg - 19.99lbs

### Temperature rating:

Minimum Maximum  
-40°C -40°F +80°C +176°F



## TECHNICAL DRAWING

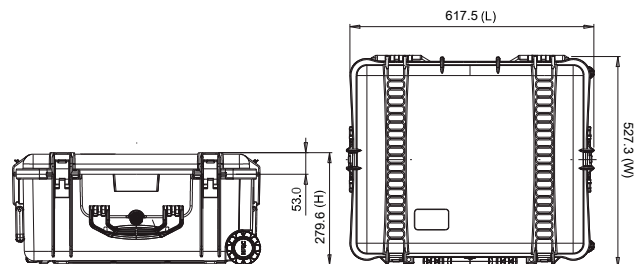

# HPRC2730W for DJI Ronin 4D-6K Combo

## R4D-2730W-01

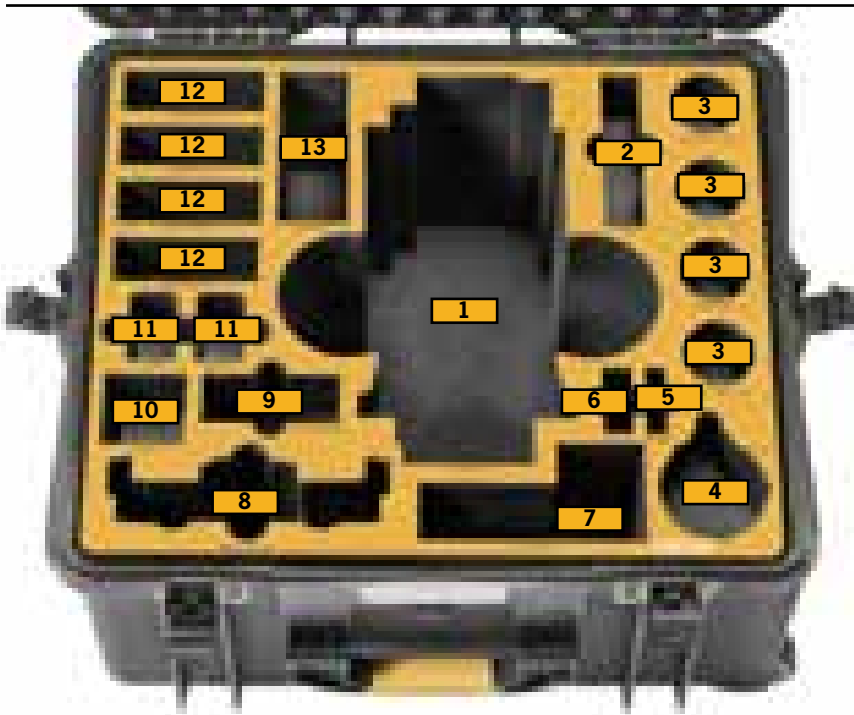
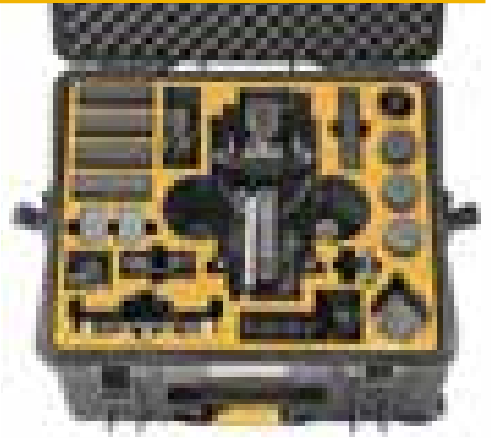

- 1** DJI Ronin 4D Mounted
- 2** Charger
- 3** Lens DL 24/35/50 mm F2.8 LS
- 4** DL Mount
- 5** MRW-G1 .SYM (Sony)
- 6** DJI Prosd 1TB
- 7** Various/Miscellaneous
- 8** DJI High-Bright Remote Monitor
- 9** DJI Zenmuse X9 Counterweight
- 10** CF Express Type B
- 11** NP-F970 (Sony)
- 12** TB50 Intelligent Flight Battery
- 13** Various/Miscellaneous



HPRC DJI RS 3 PRO COMBO

### TECHNICAL FEATURES

**Dimension:**

Internal dimension  
503x459x316(mm) - 19.80x18.07x12.44(in)  
External dimension  
616,9x531x349,6(mm) - 24.29x20.91x13.76(in)

**Weight:**

empty: 8,41kg - 18.54lbs  
with cubed foam: 10,43kg - 22.99lbs

**Temperature rating:**

Minimum            Maximum  
-40°C -40°F        +80°C +176°F



### TECHNICAL DRAWING

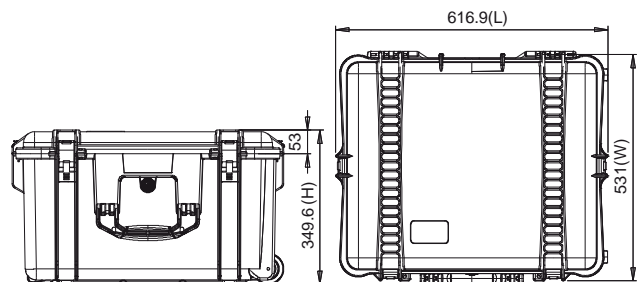



# HPRC2600 for DJI RS 4 Pro Combo

## S-RS4-2600-01

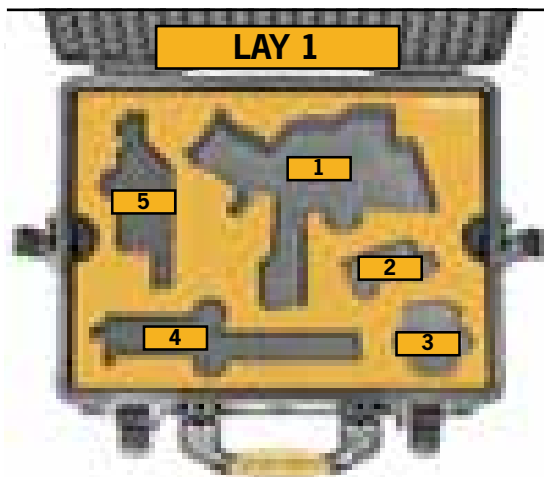
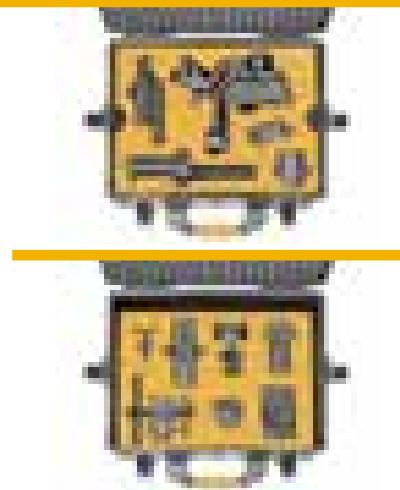

- 1** Gimbal
- 2** Focus Pro Motor
- 3** Ronin Image Transmitter
- 4** BG30 Grip with Extended Grip / Tripod
- 5** Briefcase Handle

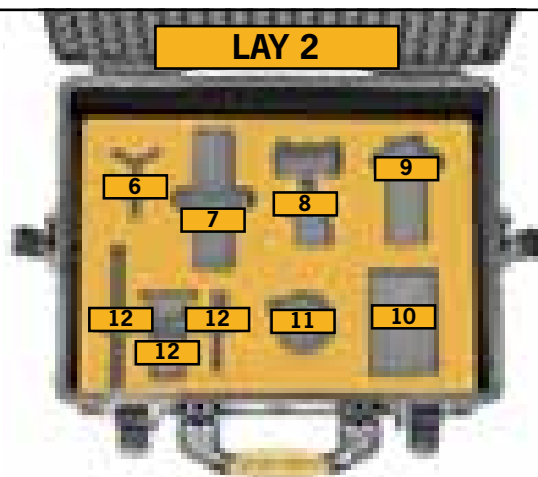

- 6** Lens-Fastening Support
- 7** Lower Quick-Release Plate
- 8** Phone Holder
- 9** Quick-Release Plate
- 10** Miscellaneous / Cables
- 11** Focus Gear Strip / Miscellaneous
- 12** Focus Pro Motor / Rod Mount Kit



HPRC DJI RS 4 PRO COMBO

### TECHNICAL FEATURES

#### Dimension:

Internal dimension:  
482,4x358,3x198,1(mm) - 18.99x14.10x7.80(in)

External dimension:  
543,4x426,8x218,1(mm) - 21.39x16.80x8.59(in)

#### Weight:

empty: 4,25kg - 9.37lbs  
with cubed foam: 5,05kg - 11.13lbs

#### Temperature rating:

Minimum Maximum  
-40°C -40°F +80°C +176°F

### TECHNICAL DRAWING

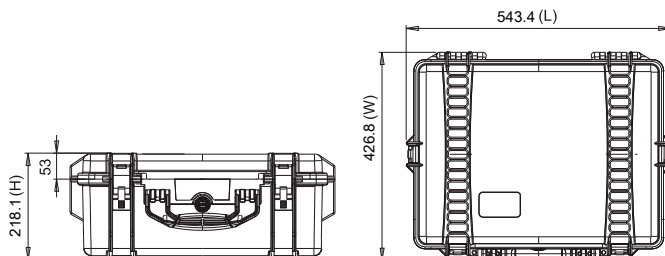

# HPRC2600 for DJI RS 3 Pro Combo

## RS3-2600-01

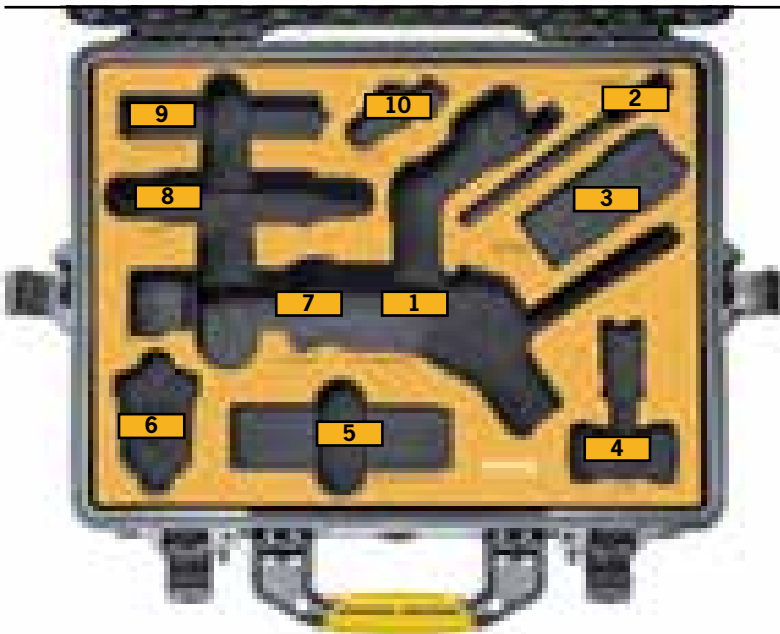

- 1** Gimbal with BG30 Grip mounted
- 2** Focus Motor Rod Mount Kit Combo
- 3** Quick-Release Plate (Arca-Swiss/Manfrotto)
- 4** Phone Holder
- 5** Lower Quick-Release Plate (Extended)
- 6** Ronin Image Transmitter
- 7** Cable/Miscellaneous
- 8** Briefcase Handle
- 9** Extended Grip/Tripod (Metal)
- 10** Focus Motor (2022)



HPRC DJI RS 3 PRO COMBO

### TECHNICAL FEATURES

#### Dimension:

Internal dimension  
482,4x358,3x198,1(mm) - 18.99x14.10x7.80(in)  
External dimension  
543,4x426,8x218,1(mm) - 21.39x16.8x8.59(in)

#### Weight:

empty: 4,25kg - 9.37lbs  
with cubed foam: 5,05kg - 11.13lbs

#### Temperature rating:

Minimum Maximum  
-40°C -40°F +80°C +176°F

### TECHNICAL DRAWING

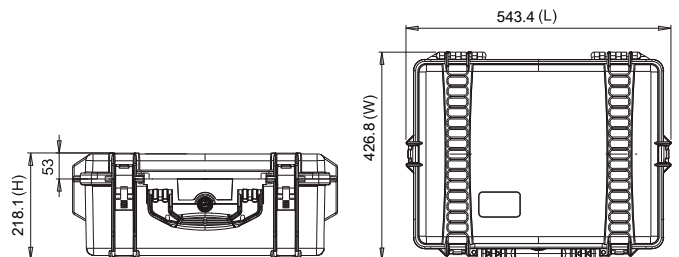

# HPRC2300 for DJI RS 3 Mini Creator Combo

## RS3M-2300-01

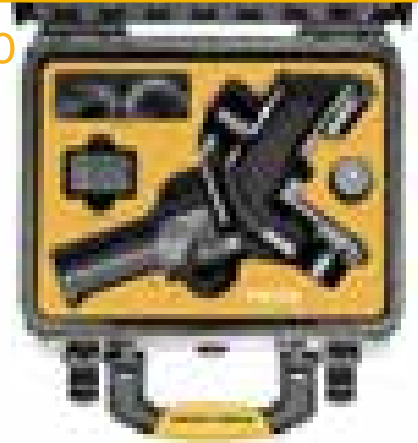

- 1** Gimbal
- 2** Mic Charging Case
- 3** Various/cable
- 4** Mini Tripod



HPRC DJI RS 3 MINI CREATOR COMBO

### TECHNICAL FEATURES

**Dimension:**

Internal dimension  
305,7x232,4x137,5(mm) - 12.04x9.15x5.41 (in)  
External dimension  
334,6x303x155,2(mm) - 13.17x11.93x6.11(in)

**Weight:**

empty: 1,75kg - 3.86lbs  
with foam: 1,90kg - 4.19lbs

**Temperature rating:**

Minimum            Maximum  
-40°C -40°F        +80°C +176°F



### TECHNICAL DRAWING

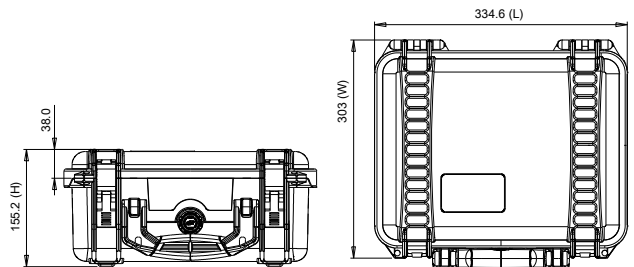

# HPRC1400 for DJI Pocket 2 Creative Combo Kit OSMPKT-1400-02



- 1** DJI Pocket 2 with 1/4"-20 Tripod Mounted
- 2** Micro Tripod
- 3** Mini Control Stick
- 4** Cable/Wireless Microphone Windscreen
- 5** Do-it-All Handle
- 6** Wireless Microphone Transmitter/SD Card
- 7** Wide-Angle Lens
- 8** Lightning (iOS) Smartphone Adapter/ USB Type-C Smartphone Adapter



## TECHNICAL FEATURES

### Dimension:

internal dimension  
180x110x40(mm) - 7.08x4.33x1.57(in)  
external dimension  
200,3x142,4x48(mm) - 7.89x5.61x1.89(in)

### Weight:

empty: 0,26kg - 0.57lbs

### Temperature rating:

Minimum            Maximum  
-40°C -40°F        +80°C +176°F



## TECHNICAL DRAWING

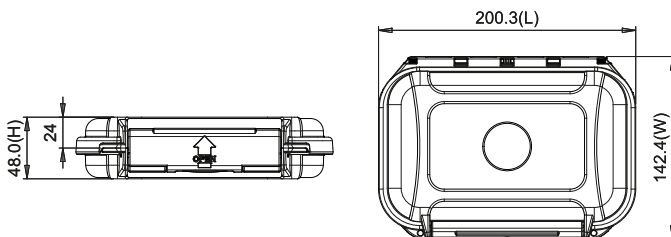

# HPRC1400 for DJI Osmo Pocket 3 Creator Combo

## S-OSMPKT-1400-03

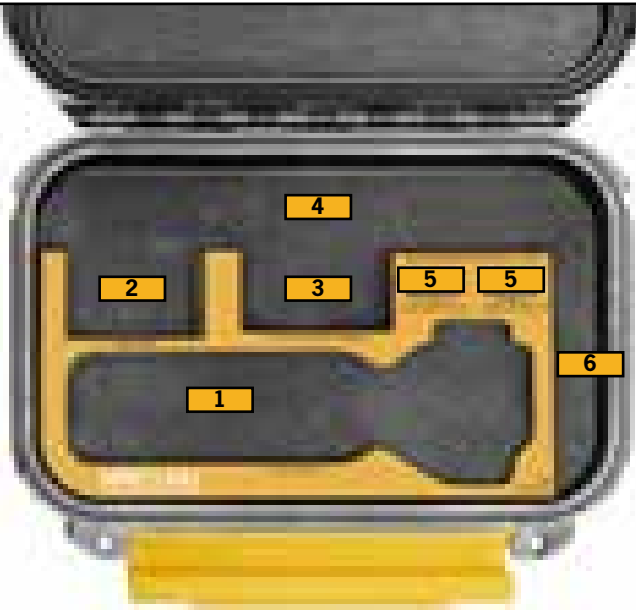
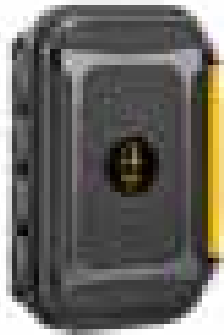

- 1** DJI Osmo Pocket 3
- 2** Battery Handle
- 3** Transmitter with attached Clip Magnet
- 4** Mini Tripod with attached Handle With 1/4" Thread
- 5** Wide-Angle Lens + Magnetic ND Filters Set
- 6** Cable + Windscreen



HPRC DJI OSMO POCKET 3 CREATOR COMBO

### TECHNICAL FEATURES

**Dimension:**

Internal dimension:  
180x110x40(mm) - 7.08x4.33x1.57(in)

External dimension:  
200,3x142,4x48(mm) - 7.89x5.61x1.89(in)

**Weight:**

empty: 0,26kg - 0.57lbs

**Temperature rating:**

Minimum                      Maximum  
-40°C -40°F                      +80°C +176°F



### TECHNICAL DRAWING

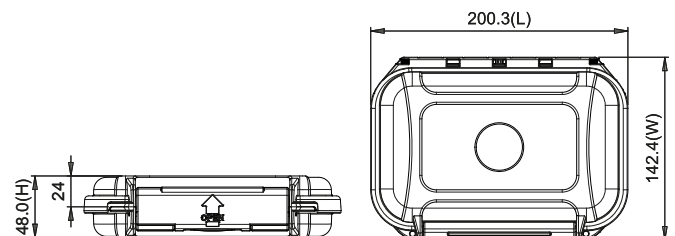



**AUTEL ROBOTICS**



HPRC READY MADE SOLUTIONS – 2025

# HPRC2460 for Autel Robotics Evo Lite+ Premium Bundle

## LITE-2460-01



- 1** Aircraft (including battery, propellers and gimbal cover)
- 2** Multi-Charger
- 3** Spare Propellers
- 4** Power Adapter
- 5** Cable
- 6** Spare Battery
- 7** Remote Control
- 8** Filter Set
- 9** Usb Cable



### TECHNICAL FEATURES

#### Dimension:

Internal dimension  
409x306x175(mm) - 16.10x12.05x6.89(in)  
External dimension  
435x377,8x193(mm) - 17.13x14.87x7.60(in)

#### Weight:

empty: 2,55kg - 5.62lbs  
with cubed foam: 3,14kg - 6.92lbs

#### Temperature rating:

Minimum Maximum  
-40°C -40°F +80°C +176°F



### TECHNICAL DRAWING

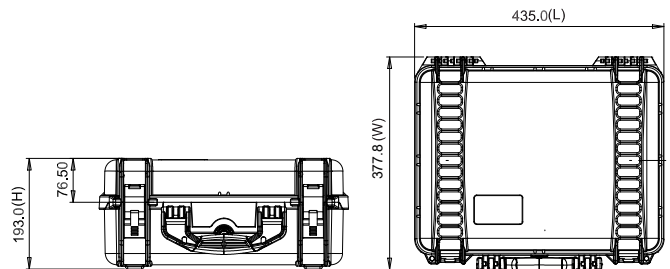

# HPRC2300 for Autel Robotics Evo Nano+ Premium Bundle

## NANO-2300-01

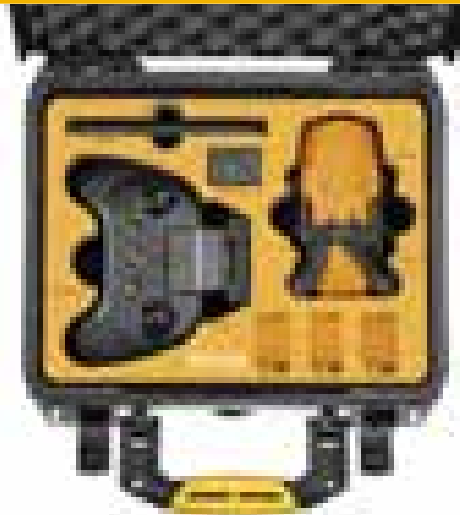

- 1** Autel Evo Nano+ including battery, propellers, gimbal cover and propeller holder
- 2** Spare Propellers
- 3** Spare Battery
- 4** Remote Control
- 5** Cables/Miscellaneous
- 6** Power Adapter
- 7** Multi-Charger



HPRC AUTEL ROBOTICS EVO NANO+

### TECHNICAL FEATURES

#### Dimension:

Internal dimension  
305,7x232,4x137,5(mm) - 12.04x9.15x5.41 (in)  
External dimension  
334,6x303x155,2(mm) - 13.17x11.93x6.11(in)

#### Weight:

empty: 1,70kg - 3.75lbs  
with foam: 1,9kg - 4.19lbs

#### Temperature rating:

Minimum                      Maximum  
-40°C -40°F                      +80°C +176°F



### TECHNICAL DRAWING

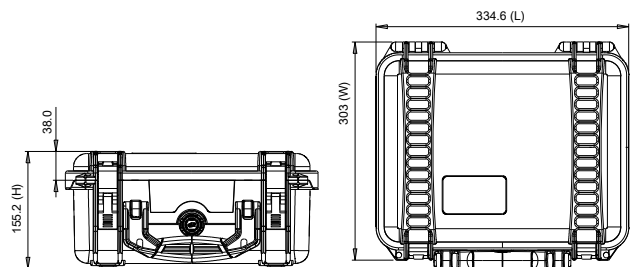



# HPRC2400 Autel Robotics Evo II 6K / 8K Drone EVO2-2400-02



- 1** Autel Robotics Evo II 6K / 8K with propellers - low noise
- 2** Remote Controller
- 3** Battery Charging Hub
- 4** Flight Battery
- 5** Cable/Propellers/Accessories
- 6** Micro USB Cable
- 7** Charger



HPRC AUTEL ROBOTICS EVO II

## TECHNICAL FEATURES

### Dimension:

Internal dimension  
377x263,9x150,8(mm) - 14.84x10.39x5.94(in)  
External dimension  
402x330,5x169,2(mm) - 15.83x13.01x6.66(in)

### Weight:

empty: 2,38kg - 5.25lbs

### Temperature rating:

Minimum Maximum  
-40°C -40°F +80°C +176°F



## TECHNICAL DRAWING

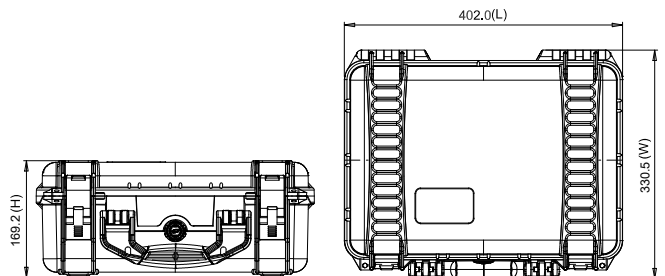



**ATOMOS**

HPRC READY MADE SOLUTIONS – 2025

# HPRC2300 for Atomos Ninja Ultra, Ninja or Ninja V NJAV-2300-01



- 1** Atomos Ninja Ultra, Ninja or Ninja V with AtomX SSD mini and battery assembled on drone
- 2** Ninja Sunhood
- 3** Battery
- 4** 12V-3A AC Power Supply
- 5** Cables/Miscellaneous
- 6** 3 Master Caddy II
- 7** Docking Station
- 8** Battery Eliminator
- 9** Fast Charger



HPRC ATOMOS NINJA ULTRA, NINJA OR NINJA V

## TECHNICAL FEATURES

### Dimension:

Internal dimension  
305,7x232,4x137,5(mm) - 12.04x9.15x5.41(in)  
External dimension  
334,6x303x155,2(mm) - 13.17x11.93x6.11(in)

### Weight:

empty: 1,75kg - 3.86lbs  
with cubed foam: 1,90kg - 4.19lbs

### Temperature rating:

Minimum Maximum  
-40°C -40°F +80°C +176°F



## TECHNICAL DRAWING

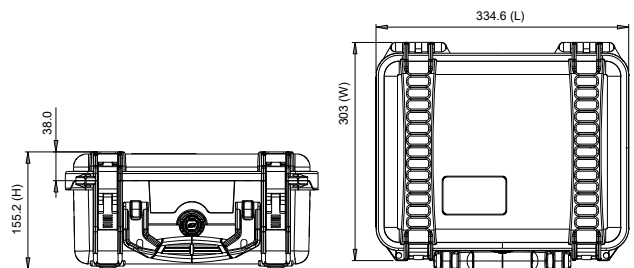

# HPRC2400 for Atomos Shogun, Shogun Ultra and Shogun Connect

## S-SHGC-2400-01

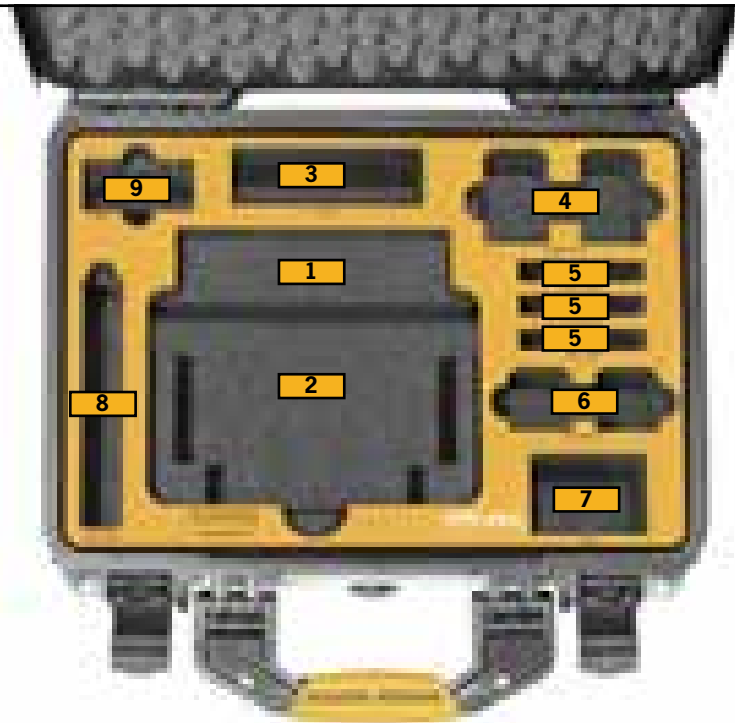
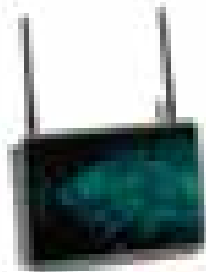

- 1** Atomos Shogun, Shogun/Ultra/Connect with Antennas Mounted
- 2** Adaptor/Miscellaneous
- 3** Various
- 4** Battery NP-F960
- 5** Master Caddy
- 6** Battery NP-F750
- 7** Charger
- 8** Docking Station
- 9** Charger



### TECHNICAL FEATURES

#### Dimension:

Internal dimension:  
377x263,9x150,8(mm) - 14.84x10.39x5.94(in)  
External dimension:  
402x330,5x169,2(mm) - 15.83x13.01x6.66(in)

#### Weight:

empty: 2,17kg - 4.78lbs  
with cubed foam: 2,58kg - 5.69lbs

#### Temperature rating:

Minimum Maximum  
-40°C -40°F +80°C +176°F



### TECHNICAL DRAWING

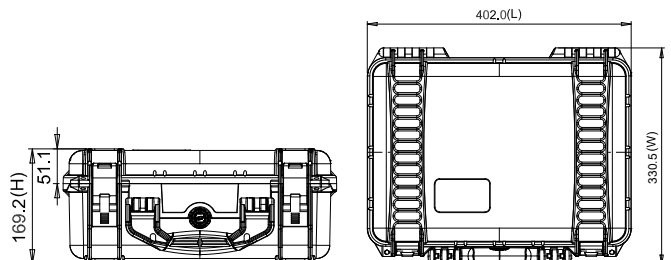

# HPRC2730W for Atomos Sumo19"/ Sumo19" SE SM19-2730W-01

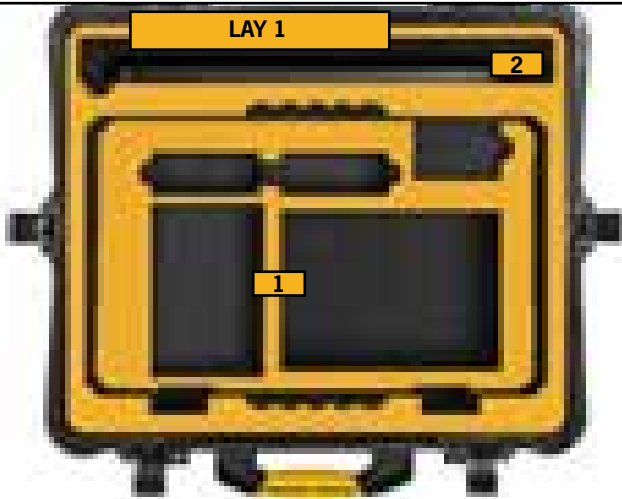

- 1** Atomos Sumo 19"/ Sumo19" SE Monitor Recorder
- 2** Atomos Sunhood

- 3** Charger
- 4** 3 Master caddy II
- 5** DM-130A Gold Mount Mini Battery or similar
- 6** D-4BA Battery Extender or similar



## TECHNICAL FEATURES

### Dimension:

internal dimension  
503x459x316(mm) - 19.80x18.07x12.44(in)  
external dimension  
616,9x531x349,6(mm) - 24.29x20.91x13.76(in)

### Weight:

empty: 8,41kg - 18.54lbs  
with cubed foam: 10,43kg - 22.99lbs

### Temperature rating:

Minimum Maximum  
-40°C -40°F +80°C +176°F



## TECHNICAL DRAWING

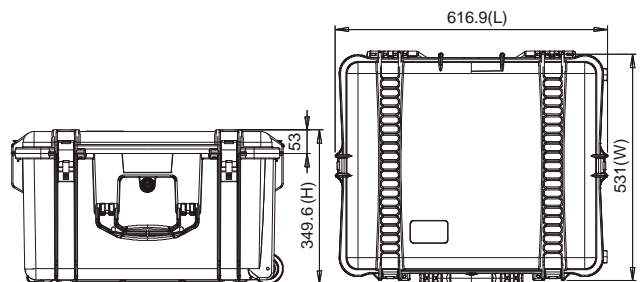



**BLACKMAGIC**

HPRC READY MADE SOLUTIONS – 2025

# HPRC2400 for Blackmagic Pocket Cinema Camera 6K Pro or Blackmagic Cinema Camera 6K

## PKT6P-2400-01

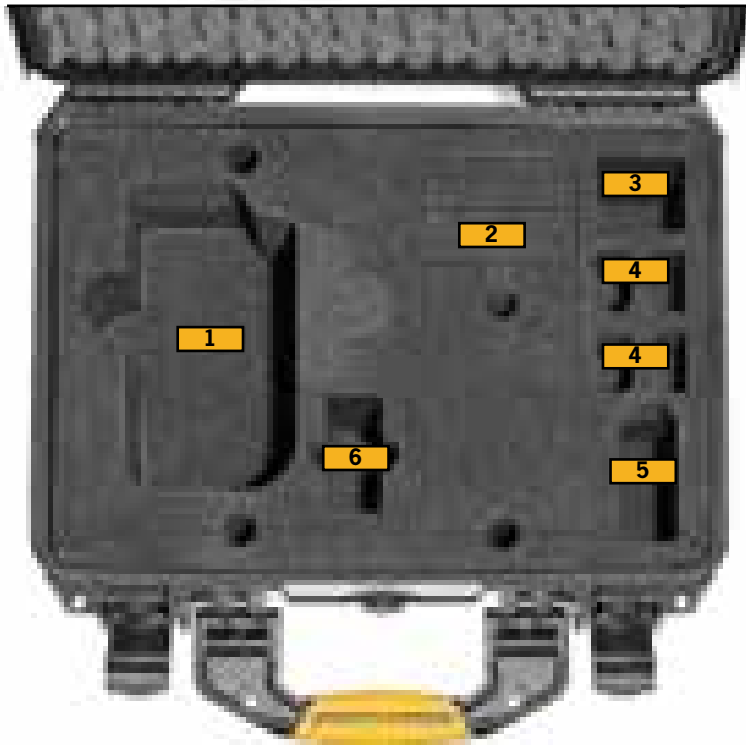

- 1** Blackmagic Pocket Cinema Camera 6K Pro / Cinema Camera 6K with or without professional cage
- 2** Lenses: Diameter Max 90mm × Length Max 220mm
- 3** International Adapters
- 4** NP-F570 Battery
- 5** 30W power supply
- 6** HPRC1100MEM

HPRC BLACKMAGIC POCKET CINEMA CAMERA 6K PRO / CINEMA CAMERA 6K

### TECHNICAL FEATURES

**Dimension:**

Internal dimension: 377x263,9x150,8(mm) - 14.84x10.39x5.94(in)

External dimension: 402x330,5x169,2(mm) - 15.83x13.01x6.66(in)

**Weight:**

empty: 2,17kg - 4.78lbs

**Temperature rating:**

Minimum            Maximum  
-40°C -40°F        +80°C +176°F



### TECHNICAL DRAWING

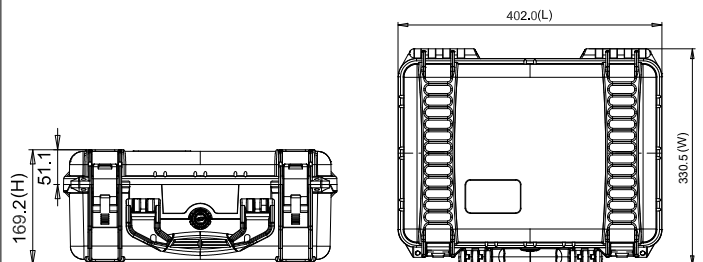

# HPRC2400 Combo for Blackmagic Pocket Cinema Camera 6K or 4K

## PKTC-2400-01



- 1** Cinema Blackmagic Pocket 4K or 6K with or without professional cage and Metabones mounted
- 2** Lenses: Diameter Max 90mm x Length Max 220mm
- 3** International Adapters
- 4** LP-E6 Battery
- 5** 30W power supply
- 6** HPRC1100MEM

HPRC BLACKMAGIC POCKET CAMERA 6K OR 4K

### TECHNICAL FEATURES

**Dimension:**

Internal dimension  
377x263,9x150,8(mm) - 14.84x10.39x5.94(in)  
External dimension  
402x330,5x169,2(mm) - 15.83x13.01x6.66(in)

**Weight:**

empty: 2,23kg - 4,91lbs  
with cubed foam: 2,55kg - 5.62lbs

**Temperature rating:**

Minimum	Maximum
-40°C -40°F	+80°C +176°F



### TECHNICAL DRAWING

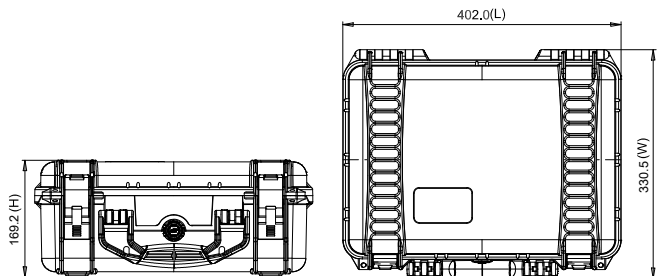



# HPRC5200 for Blackmagic Studio Camera 6K Pro/4K Pro G2/4K Plus S-BMS-5200-01



- 1** Blackmagic Studio Camera 6K PRO/4K PRO G2/4K PLUS
- 2** Charger + Adaptor
- 3** Tripod Plate
- 4** 3x Camera Numbers



☆ Additional foam inserts for BM Studio Camera 4k PRO G2 / 4K PLUS

HPRC BLACKMAGIC STUDIO CAMERA 6K PRO/4K PRO G2/4K PLUS

## TECHNICAL FEATURES

### Dimension:

Internal dimension  
772x302x210(mm) - 30.39x11.89x8.26(in)

External dimension:  
802x355x246,7(mm) - 31.57x13.97x9.71(in)

### Weight:

empty: 5,05kg - 11.10lbs  
with cubed foam: 6,20kg - 13.70lbs

### Temperature rating:

Minimum	Maximum
-40°C -40°F	+80°C +176°F

## TECHNICAL DRAWING

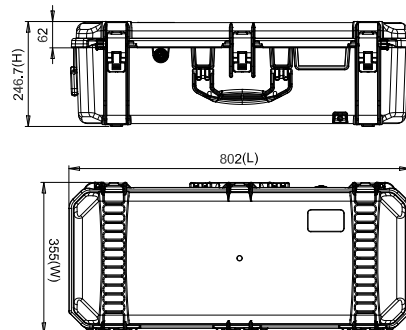

# HPRC2760W for Blackmagic Design Atem Television Studio 4K8 /HD8 /HD8 ISO + ATEM Microphone Converter **S-ATS-2760W-01**



- 1** Atem Television Studio 4K8 / HD8 / HD8 ISO
- 2** Atem Microphone Converter



HPRC BLACKMAGIC ATEM

## TECHNICAL FEATURES

### Dimension:

Internal dimension  
690x450x301(mm) - 27.16x17.72x11.85(in)  
External dimension:  
750x511x329(mm) - 29.53x20.12x12.95(in)

### Weight:

empty: 8,93kg - 19.69lbs  
with cubed foam: 10,72kg - 23.63lbs

### Temperature rating:

Minimum Maximum  
-40°C -40°F +80°C +176°F



## TECHNICAL DRAWING

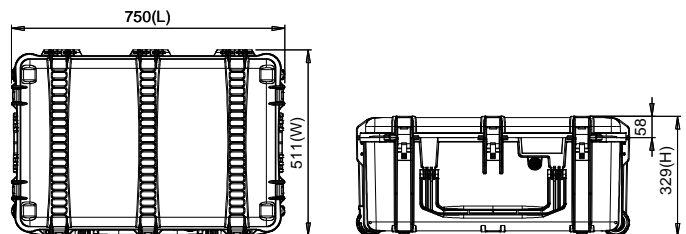

# HPRC2710 for Blackmagic Design Atem Camera Control Panel

## S-ACCP-2710-01

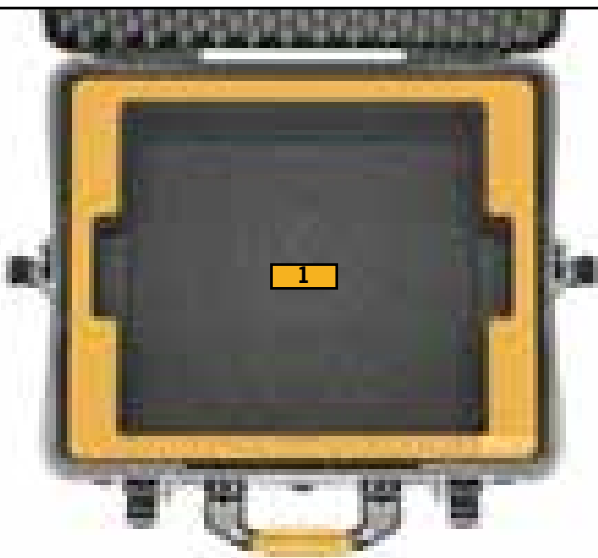

**1** Atem Camera Control Panel



HPRC BLACKMAGIC ATEM

### TECHNICAL FEATURES

**Dimension:**

Internal dimension  
555x459x256(mm) - 21.85x18.07x10.08(in)

External dimension:  
617x525x280(mm) - 24.29x20.67x11.02(in)

**Weight:**

empty: 6,56kg - 14.46lbs  
with cubed foam: 7,96kg - 17.55lbs

**Temperature rating:**

Minimum            Maximum  
-40°C -40°F        +80°C +176°F

### TECHNICAL DRAWING

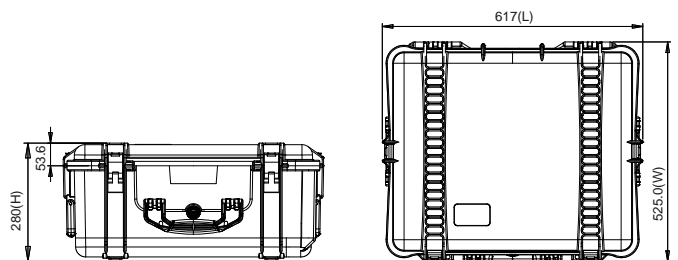

# HPRC2300 for Atem Mini, Atem Mini Pro and Atem Mini Pro ISO

## AMI-2300-01

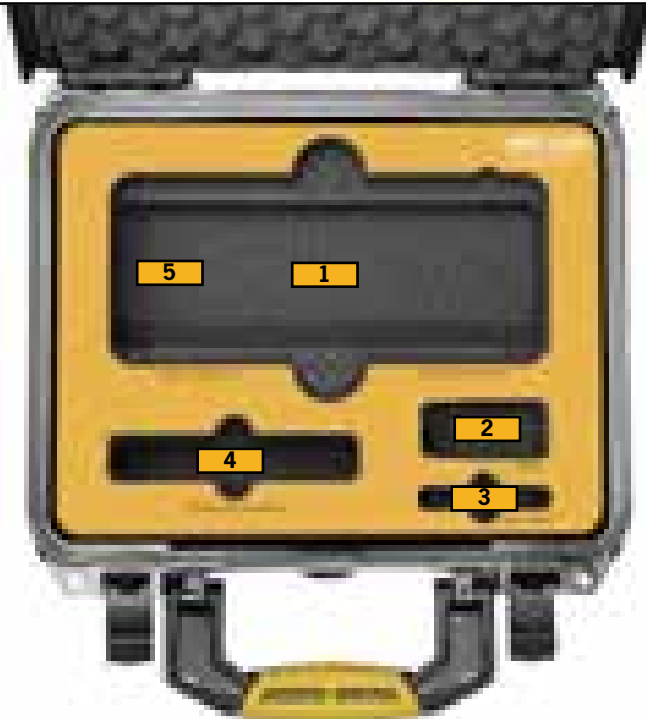

- 1** Atem Mini/Mini Pro/Mini Pro ISO
- 2** Charger
- 3** Angelbird SSD2GO
- 4** Blackmagic Atem Streaming Bridge
- 5** HDMI cables/Miscellaneous



HPRC ATEM MINI / PRO / PRO ISO

### TECHNICAL FEATURES

**Dimension:**

Internal dimension  
305,7x232,4x137,5(mm) - 12.04x9.15x5.41(in)  
External dimension  
334,6x303x155,2(mm) - 13.17x11.93x6.11(in)

**Weight:**

empty: 1,75kg - 3.86lbs  
with cubed foam: 1,90kg - 4.19lbs

**Temperature rating:**

Minimum                      Maximum  
-40°C -40°F                      +80°C +176°F



### TECHNICAL DRAWING

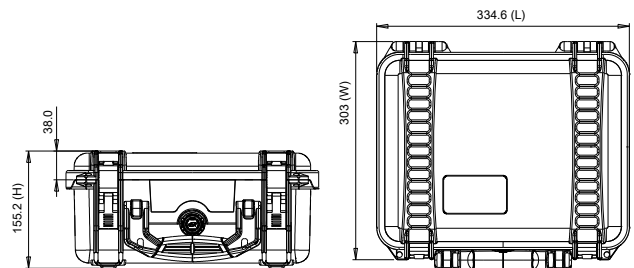

# HPRC2500 for Atem Mini Extreme and Atem Mini Extreme ISO

## AME-2500-01



- 1** Atem Mini Extreme/Mini Extreme ISO
- 2** Miscellaneous
- 3** Charger
- 4** Blackmagic Atem Streaming Bridge
- 5** Angelbird SSD2GO
- 6** HDMI cables/Miscellaneous



HPRC ATEM MINI EXTREME / EXTREME ISO

### TECHNICAL FEATURES

#### Dimension:

internal dimension  
449,8x322,9x174,9(mm) - 17.71x12.71x6.89(in)  
external dimension  
478,1x389,4x194(mm) - 18.82x15.33x7.64(in)

#### Weight:

empty: 3,08kg - 6.79lbs  
with cubed foam: 3,71kg - 8.18lbs

#### Temperature rating:

Minimum            Maximum  
-40°C -40°F        +80°C +176°F



### TECHNICAL DRAWING

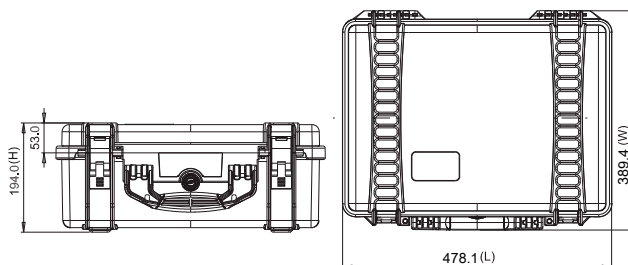

# HPRC2710 for Blackmagic Atem 1 M/E

## ADV1-2710-01



Blackmagicdesign

Blackmagic Design Atem 1 M/E Advanced Panel



HPRC BLACKMAGIC ATEM 1 M/E

### TECHNICAL FEATURES

**Dimension:**  
 internal dimension  
 555x459x256(mm) - 21.85x18.07x10.08(in)  
 external dimension  
 617x525x280(mm) - 24.29x20.67x11.02(in)

**Weight:**  
 empty: 6,43 kg - 14.18 lbs  
 with foam: 7,45 kg - 16.42 lbs

**Temperature rating:**  
 Minimum            Maximum  
 -40°C -40°F        +80°C +176°F

### TECHNICAL DRAWING

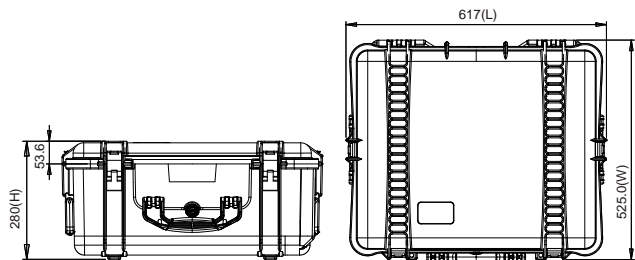

# HPRC2730W for Blackmagic Ursa Mini Pro/Broadcast

## URS2730W-03



Blackmagicdesign **FOR URSA MINI PRO and URSA BROADCAST**



- 1** BlackMagic Ursa Mini Pro / Broadcast with shoulder pad and top handle mounted
- 2** Tripod Plate
- 3** Shoulder Mount kit - Rods clamps
- 4** Batteries
- 5** Lens
- 6** Accessories / Cables
- 7** HPRC1100 Memory card holder for CFast/SDHC cards
- 8** Charger standard and Charger SWIT S-3802S

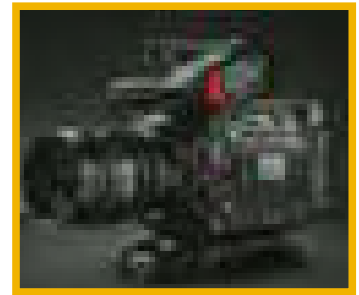

HPRC BLACKMAGIC URSA MINI PRO

### TECHNICAL FEATURES

**Dimension:**

internal dimension  
503x459x316(mm) - 19.80x18.07x12.44(in)  
external dimension  
616,9x531x349,6(mm) - 24.29x20.91x13.76(in)

**Weight:**

empty: 8,41kg - 18.54lbs  
with cubed foam: 10,43kg - 22.99lbs

**Temperature rating:**

Minimum                      Maximum  
-40°C -40°F                      +80°C +176°F



### TECHNICAL DRAWING

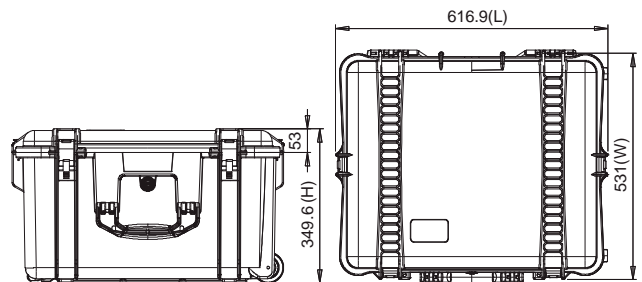



SONY

α  
7R

SONY

HPRC READY MADE SOLUTIONS – 2025



# HPRC2460 for Sony Alpha 7

## ALP2460-01



FOR SONY ALPHA 7

HPRC2460 for ALPHA 7 is a special edition, designed to safely carry your SONY Alpha Series.



- 1** Sony A7/A7R/A7S/A7II/A7RII/A7SII / A7SIII / a6300/ Alpha 7 with or without professional cage and lenses mounted (EF/F/PL-Mount/Leica R)
- 2** Lenses: Sony FE 50/1.4, 50/2,8 Macro, 24-70/2.8 G, 85/1,4 G, 16-35/4, 24-70/4, 28-70/3.5-5.6, 28/2.0 - SONY ZA 35/2.8, 35/1.4, 50/1.4, 50/1,8 55/1.8/ 10-18/4 - Zeiss Loxia 21/2.8, 35/2.0, 50/2.0
- 3** Battery chargers, cables
- 4** Accessories (baseplate, rods, top grip handles, lockports, cables, batteries, controllers, GoPro)
- 5** external recorder Atomos/Sound Device etc



### TECHNICAL FEATURES

**Dimension:**  
 internal dimension  
 409x306x175(mm) - 16.1x12.05x6.89(in)  
 external dimension  
 435x377,8x193(mm) - 17.13x14.87x7.60(in)

**Weight:**  
 empty: 2,57kg - 5.65lbs  
 with cubed foam: 2,97kg - 6.55lbs

**Temperature rating:**  
 Minimum Maximum  
 -40°C -40°F +80°C +176°F



### TECHNICAL DRAWING

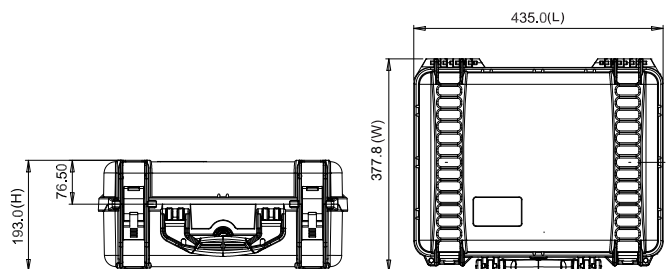

# HPRC2400 for Sony FX3

## FX3-2400-01



- 1** Sony FX3
- 2** Lenses: Diameter Max 90mm × Length Max 220mm
- 3** XLR Handle Unit
- 4** Battery Charger BC-QZ1
- 5** Battery NP-FZ100
- 6** Cable



HPRC SONY FX3

### TECHNICAL FEATURES

**Dimension:**

Internal dimension  
377x263,9x150,8(mm) - 14.84x10.39x5.94(in)  
External dimension  
402x330,5x169,2(mm) - 15.83x13.01x6.66(in)

**Weight:**

empty: 2,49kg - 5.48lbs  
with cubed foam: 3,20kg - 7.04lbs

**Temperature rating:**

Minimum Maximum  
-40°C -40°F +80°C +176°F



### TECHNICAL DRAWING

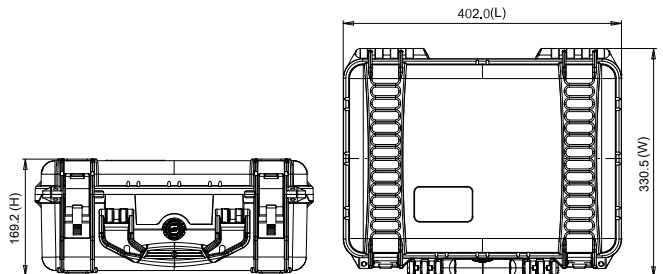

# HPRC2550W for Sony ILME-FX6 FX6-2550W-01

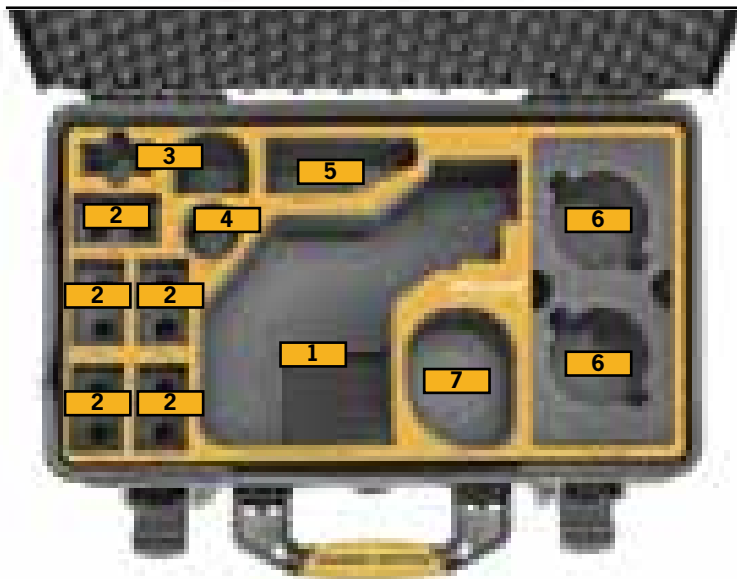
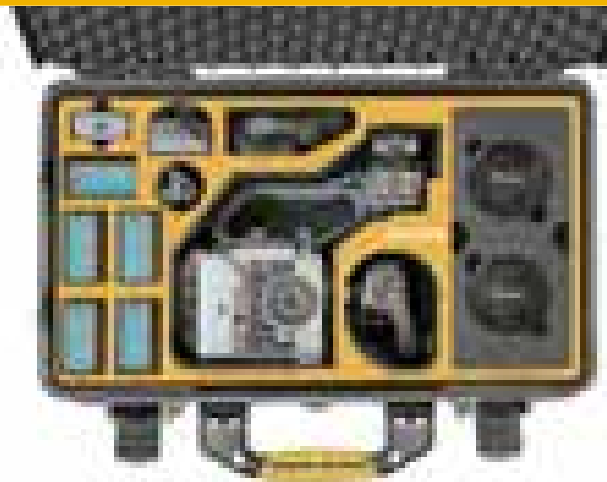

- 1** Sony ILME-FX6 Cinema Line + Smart Handle
- 2** BP-U35 or BP-U100 Battery
- 3** Charger
- 4** Cables
- 5** LCD Monitor 3,5"
- 6** 2x Lenses GM or x Tele GM
- 7** Smart Grip



HPRC SONY ILME-FX6

## TECHNICAL FEATURES

### Dimension:

internal dimension  
513x288x200(mm) - 20.19x11.34x7.87(in)  
external dimension  
549x346x236(mm) - 21.61x13.62x9.29(in)

### Weight:

empty: 4,35kg - 9.57lbs  
with foam: 5,04kg - 11.10 lbs

### Temperature rating:

Minimum Maximum  
-40°C -40°F +80°C +176°F



## TECHNICAL DRAWING

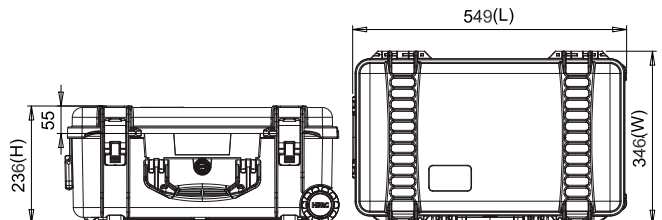

# HPRC2700W for Sony PXW-FX9

## FX9-2700W-01



**SONY**  
PXW-FX9



- 1 Sony Camcorder
- 2 Viewfinder LCD
- 3 External Microphone
- 4 Battery Sony BP-U Series
- 5 Lens Adapter Metabones
- 6 Sony XQD/SD Card
- 7 Canon CINE Prime Lens
- 8 Cine Lenses up to 105mm Ø
- 9 Photo Lenses up to 105mm Ø
- 10 Hand Grip
- 11 Cable
- 12 Charger
- 13 HPRC1100 MEMBLB



### TECHNICAL FEATURES

**Dimension:**

Internal dimension  
554,7x458,7x246(mm) - 21.84x18.06x9.69(in)  
External dimension  
617,5x527,3x279,6(mm) - 24.31x20.76x11.0(in)

**Weight:**

empty: 7,75kg - 17.09lbs  
with cubed foam: 9,07kg - 19.99lbs

**Temperature rating:**

Minimum Maximum  
-40°C -40°F +80°C +176°F



### TECHNICAL DRAWING

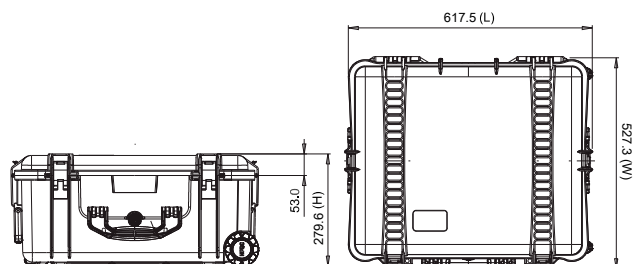

HPRC SONY PXW-FX9

# HPRC2700W for Sony Burano 8K Camera Cinema Line

## S-BRN-2700W-01

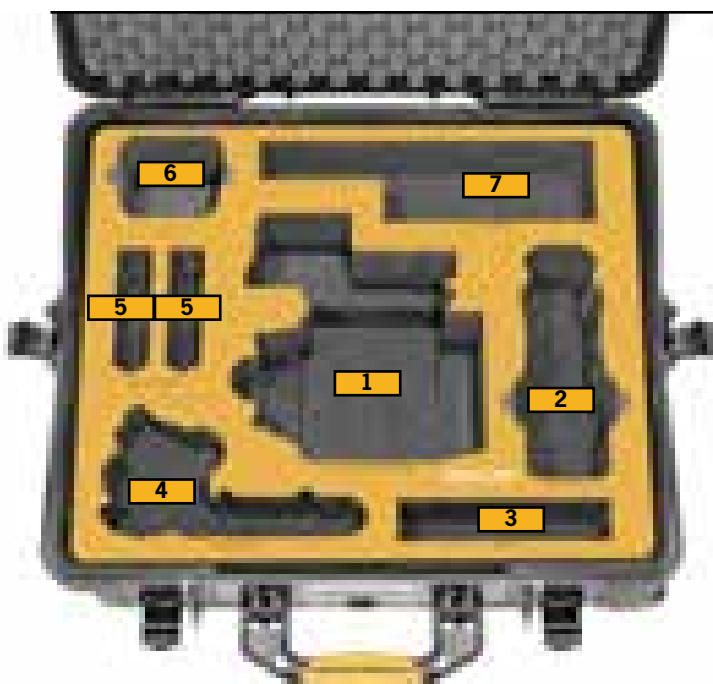

- 1** Sony Burano 8K Camera with Handle (3 options) & PL mount
- 2** Viewfinder with Mounted LCD Monitor
- 3** Accessories
- 4** Remote Control Grip GP-VR100
- 5** HPRC 1300 CFEBLB Cards Holder
- 6** Batteries
- 7** Miscellaneous / Card Reader



HPRC SONY BURANO 8K CAMERA CINEMA LINE

### TECHNICAL FEATURES

#### Dimension:

Internal dimension  
554,7x458,7x246(mm) - 21.84x18.06x9.69(in)  
External dimension:  
617,5x527,3x279,6(mm) - 24.31x20.76x11(in)

#### Weight:

empty: 7,75kg - 17.09lbs  
with cubed foam: 9,07kg - 19.99lbs

#### Temperature rating:

Minimum            Maximum  
-40°C -40°F        +80°C +176°F



### TECHNICAL DRAWING

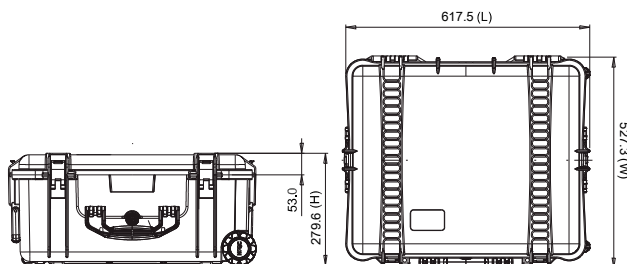

# HPRC4400 for Sony ILME-FR7

## S-FR7-4400-01

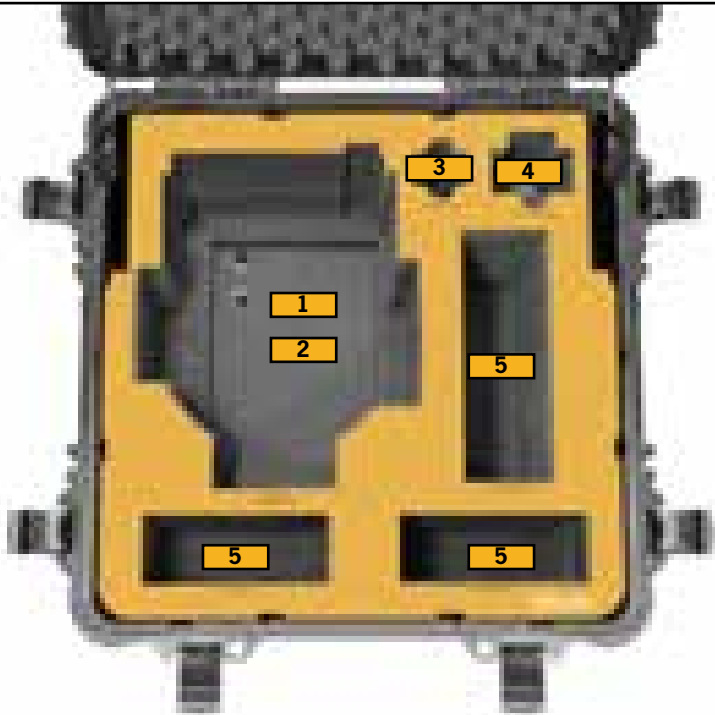

- 1 Sony Ilme FR7
- 2 Miscellaneous
- 3 Remote Controller
- 4 Cables Adaptors/Charger
- 5 Various/Miscellaneous



HPRC SONY ILME-FR7

### TECHNICAL FEATURES

#### Dimension:

Internal dimension:  
420x420x389(mm) - 16.54x16.54x15.31(in)

External dimension:  
482x481x437(mm) - 18.98x18.94x17.20(in)

#### Weight:

empty: 6,70kg - 14.77lbs  
with cubed foam: 8,90kg - 19.62lbs

#### Temperature rating:

Minimum Maximum  
-40°C -40°F +80°C +176°F

### TECHNICAL DRAWING

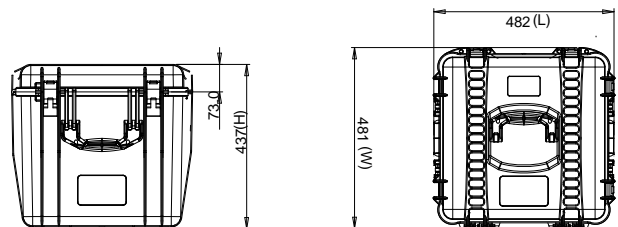

# HPRC2460 for Sony IP500 PTZ Camera Remote Controller

## S-IP500-2460-01

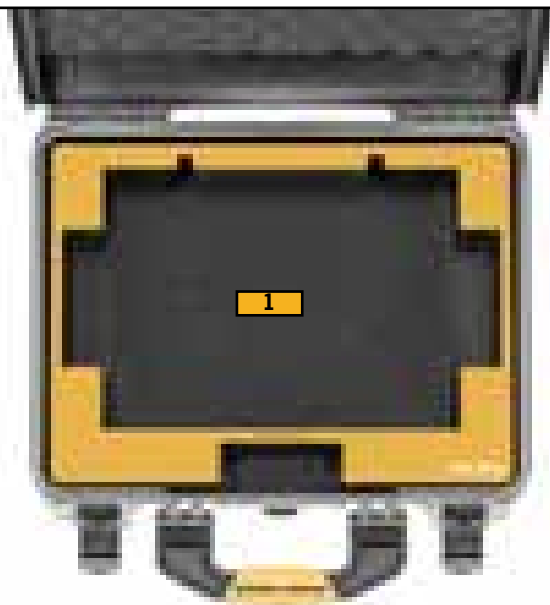
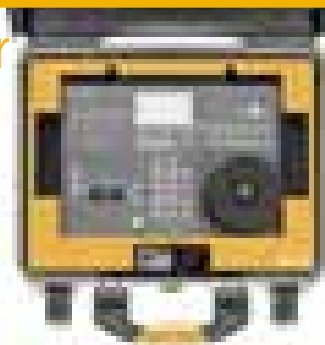

**1** Sony IP500 PTZ Camera Remote Controller



HPRC SONY IP500 PTZ CAMERA REMOTE CONTROLLER

### TECHNICAL FEATURES

**Dimension:**

Internal dimension:  
409x306x175(mm) - 16.10x12.05x6.89(in)  
External dimension:  
435x377,8x193(mm) - 17.13x14.87x7.60(in)



**Weight:**

empty: 2,55kg - 5.62lbs  
with cubed foam: 3,14kg - 6.92lbs

**Temperature rating:**

Minimum Maximum  
-40°C -40°F +80°C +176°F

### TECHNICAL DRAWING

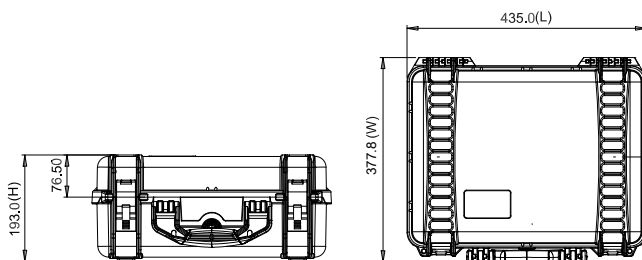

# HPRC2600W for Sony PXW-Z280

## Z280-2600W-01

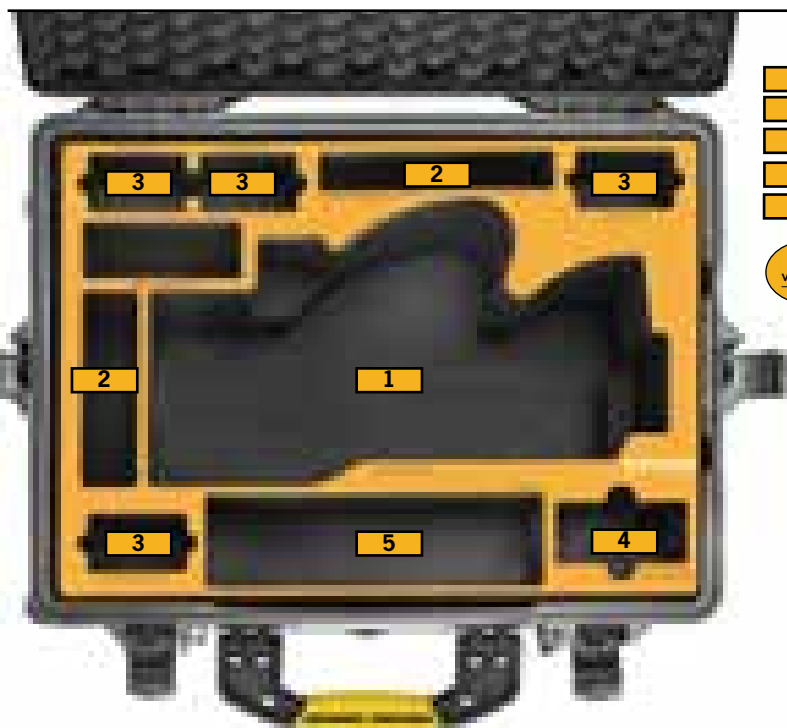

- 1** Sony Camcorder PXW-Z280
- 2** Cables/Accessories/Miscellaneous
- 3** Battery Sony BPU – U60
- 4** Compact 4K Wide Conversion
- 5** Microphone



HPRC SONY PXWZ280

### TECHNICAL FEATURES

#### Dimension:

Internal dimension  
482,4x358,3x217,6(mm) - 18.99x14.1x8.57(in)  
External dimension  
546,9x426,8x250,7(mm) - 21.53x16.8x9.87(in)

#### Weight:

empty: 6,05kg - 13.34lbs  
with cubed foam: 6,97kg - 15.37lbs

#### Temperature rating:

Minimum Maximum  
-40°C -40°F +80°C +176°F



### TECHNICAL DRAWING

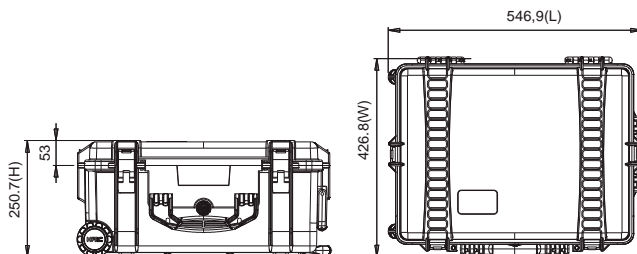



# HPRC2700W for Sony PXW-Z190V

## Z190-2700W-01



**SONY**  
PXW-Z190V



- 1** Sony Camcorder PXW-Z190VC
- 2** BC-U1 battery charger
- 3** Battery Sony BPU \Swit S-8U63
- 4** Microphone
- 5** Wireless Audio Set Sony UWP-D11/K51PRO
- 6** Cables/Accessories/Miscellaneous



HPRC SONY PXWZ190V

### TECHNICAL FEATURES

#### Dimension:

Internal dimension  
554,7x458,7x246(mm) - 21.84x18.06x9.69(in)  
External dimension  
617,5x527,3x279,6(mm) - 24.31x20.76x11.0(in)

#### Weight:

empty: 7,75kg - 17.09lbs  
with cubed foam: 9,07kg - 19.99lbs

#### Temperature rating:

Minimum Maximum  
-40°C -40°F +80°C +176°F



### TECHNICAL DRAWING

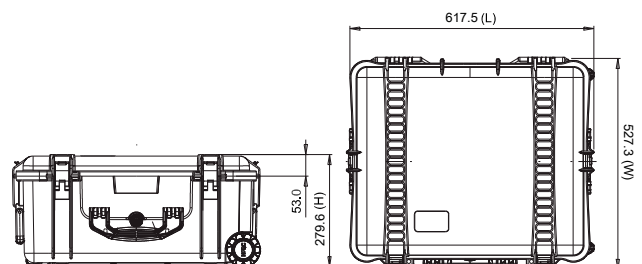



**CANON**

HPRC READY MADE SOLUTIONS – 2025

# HPRC2300 for Canon Eos R5 / R6

## CR5-2300-01

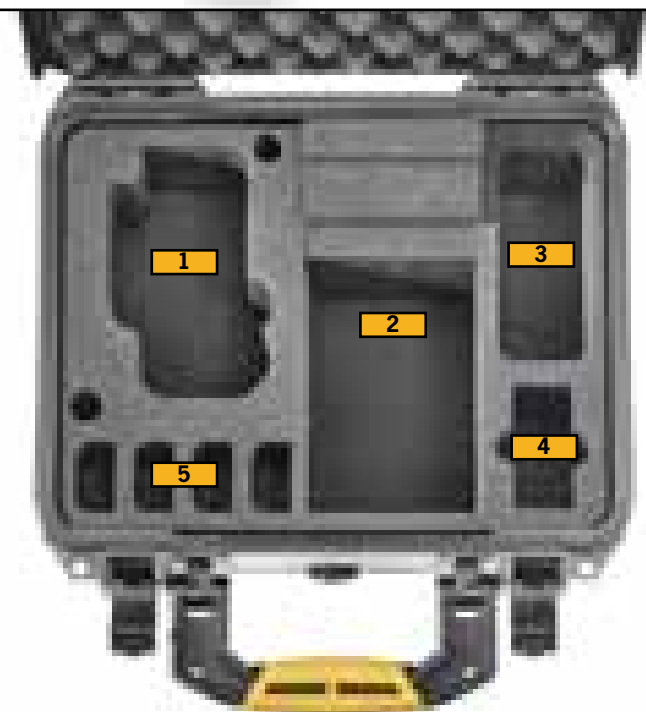

- 1** Canon Eos R5 / R6 Mirrorless Digital Camera (with or without professional cage)
- 2** Lenses: Diameter Max 90mm x Length Max 220mm
- 3** Cable/Miscellaneous
- 4** LC-E6 Charger for LP-E6 Battery Pack
- 5** LP-E6NH Lithium-Ion Battery (7.2V, 2130mAh)



### TECHNICAL FEATURES

**Dimension:**  
 Internal dimension  
 305,7x232,4x137,5(mm) - 12.04x9.15x5.41(in)  
 External dimension  
 334,6x303x155,2(mm) - 13.17x11.93x6.11(in)

**Weight:**  
 empty: 1,75kg - 3.86lbs  
 with cubed foam: 1,90kg - 4.19lbs

**Temperature rating:**  
 Minimum Maximum  
 -40°C -40°F +80°C +176°F



### TECHNICAL DRAWING

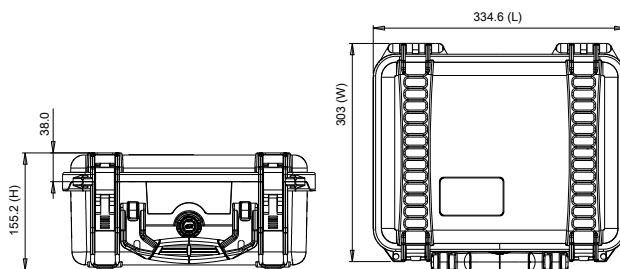

# HPRC2700W for Canon Eos C300 Mark III / Eos C500 Mark II

## C300-2700W-01



- 1** Eos C300 Mark III / Eos C500 Mark II Body
- 2** Lens CN-E18-80
- 3** Lens 110/90 mm diameter, depth 180mm
- 4** Monitor
- 5** Handle
- 6** Charger
- 7** Various/Cable
- 8** Battery BP-A30/BP-A60
- 9** Charger
- 10** HPRC1100MEM



### TECHNICAL FEATURES

#### Dimension:

Internal dimension  
554,7x458,7x246(mm) - 21.84x18.06x9.69(in)  
External dimension  
617,5x527,3x279,6(mm) - 24.31x20.76x11.0(in)

#### Weight:

empty: 7,75kg - 17.09lbs

#### Temperature rating:

Minimum	Maximum
-40°C -40°F	+80°C +176°F



### TECHNICAL DRAWING

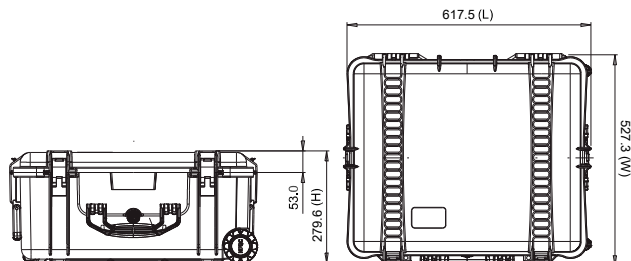

# HPRC2600 for Canon Eos C70

## C70-2600-01



- 1** Canon Eos C70
- 2** Batteries BP-A60/BP-A30
- 3** Lens Canon RF 24-105 or similar
- 4** Lens Canon RF 15-35 or similar
- 5** Lens Canon RF 70-200 or similar
- 6** Lens Canon RF 24-70 or similar
- 7** Canon Adapter EF-RF 0.71x
- 8** HPRC1300MEMBLB
- 9** CA-CP200L
- 10** Miscellaneous
- 11** Battery Charger CG-A20 OTH
- 12** Handle unit



### TECHNICAL FEATURES

#### Dimension:

internal dimension  
482,4x358,3x198,1(mm) - 18.99x14.1x7.8(in)  
external dimension  
543,4x426,8x218,1(mm) - 21.39x16.8x8.59(in)

#### Weight:

empty: 4,25kg - 9.37lbs  
with cubed foam: 5,05kg - 11.13lbs

#### Temperature rating:

Minimum Maximum  
-40°C -40°F +80°C +176°F

### TECHNICAL DRAWING

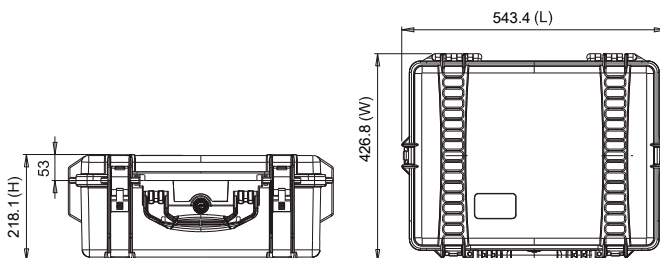

# HPRC2600 for Canon Eos C200

## C200-2600-01



- 1** Canon Eos C200 With Camera Grip Mounted
- 2** Handle Unit Hdu-2
- 3** Monitor Lcd Lm-V1, Lcd La-V1
- 4** Compact Power Adaptor Ca-A10
- 5** Compact Adaptor Cp200b
- 6** Lenses Ef85mm/16-35/24-70/24-105Mm
- 7** HPRC1100MEM
- 8** Battery Pack A30/A60
- 9** Battery Charger A-20
- 10** Miscellaneous Accessories
- 11** Screw
- 12** Allen Key



### TECHNICAL FEATURES

**Dimension:**

internal dimension  
482,4x358,3x198,1(mm) - 18.99x14.1x7.8(in)  
external dimension  
543,4x426,8x218,1(mm) - 21.39x16.8x8.59(in)

**Weight:**

empty: 4,31kg - 9.50lbs  
with cubed foam: 4,84kg - 10.663lbs

**Temperature rating:**

Minimum Maximum  
-40°C -40°F +80°C +176°F

### TECHNICAL DRAWING

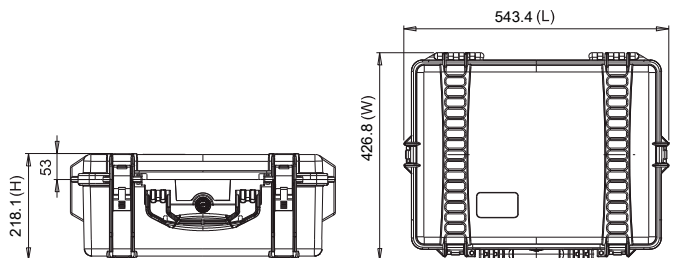

# HPRC2600 for Canon Eos C100

## C100-2600-01



- 1** Canon Eos C100 With Viewfinder and Camera Grip Mounted
- 2** Handle Unit
- 3** Lenses Ef85mm/16-35/24-70/24-105Mm
- 4** Battery Pack Bp 955
- 5** Battery Pack Bp 975
- 6** Battery Charger Cg-940
- 7** Compact Adaptor Ca-941
- 8** Miscellaneous Accessories
- 9** HPRC1100MEM



HPRC CANON EOS C100

### TECHNICAL FEATURES

#### Dimension:

internal dimension  
482,4x358,3x198,1(mm) - 18.99x14.1x7.8(in)  
external dimension  
543,4x426,8x218,1(mm) - 21.39x16.8x8.59(in)

#### Weight:

empty: 4,25kg - 9.37lbs  
with cubed foam: 5,05kg - 11.13lbs

#### Temperature rating:

Minimum Maximum  
-40°C -40°F +80°C +176°F

### TECHNICAL DRAWING

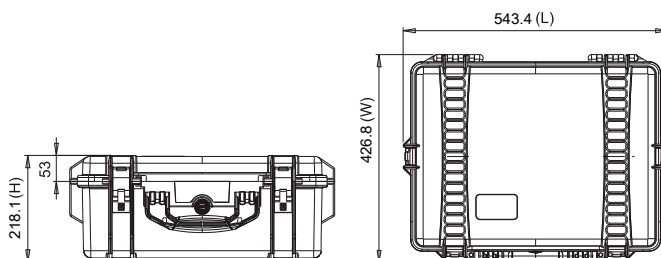



**MOZA**

HPRC READY MADE SOLUTIONS - 2025



# HPRC2530 for Moza Air2 Ifocus

## MAIR2-2530-01

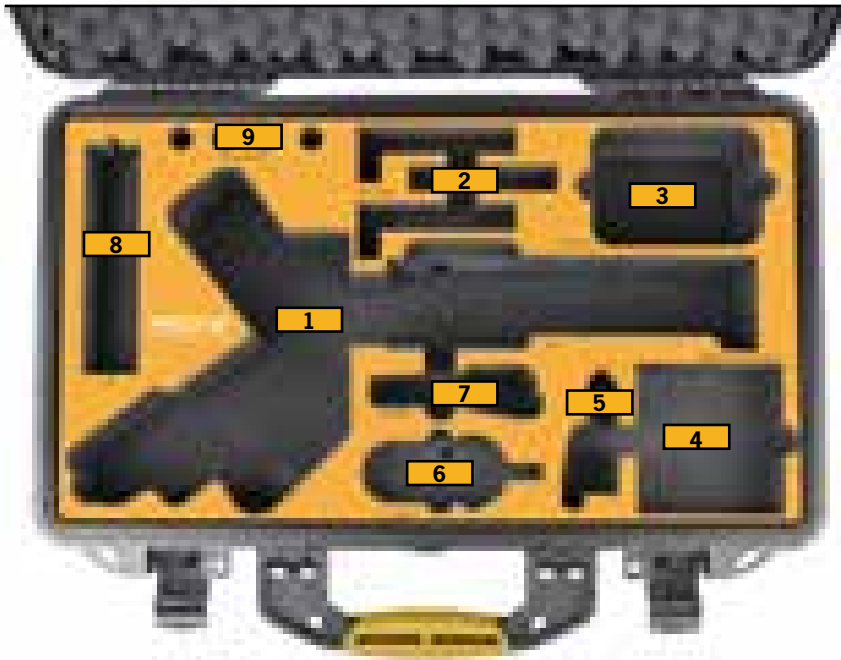

- 1** Gimbal
- 2** Quick Release Plate
- 3** Cable storage bag
- 4** Intelligent Charger and 18650 batteries
- 5** Ifocus M
- 6** Ifocus Handunit
- 7** Ifocus Motor
- 8** Tripod
- 9** Follow focus install pipe



### TECHNICAL FEATURES

**Dimension:**  
 internal dimension 513x288x132(mm) - 20.20x11.34x5.20(in)  
 external dimension 540x350x153(mm) - 21.26x13.78x6.02(in)

**Weight:**  
 empty: 3,20kg - 7.05lbs  
 with cubed foam: 3,26kg - 7.19lbs

**Temperature rating:**  
 Minimum -40°C -40°F      Maximum +80°C +176°F



### TECHNICAL DRAWING

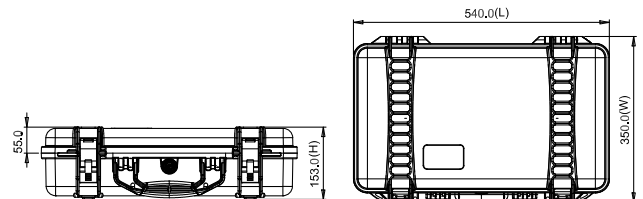



## ZHIYUN CRANE

HPRC READY MADE SOLUTIONS – 2025

# HPRC2700W for Zhiyun Crane 3 Lab Master package CR3-2700W-01

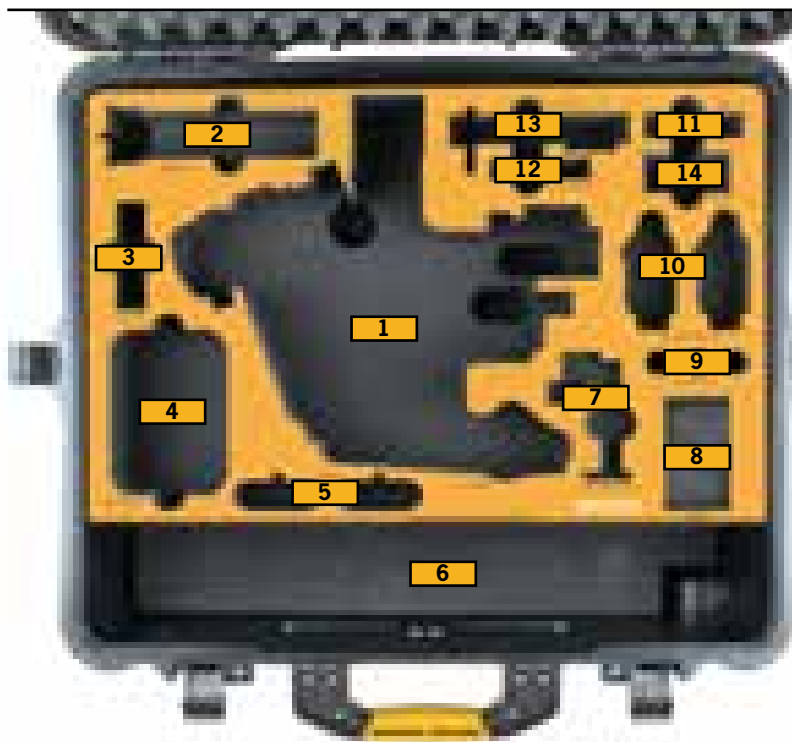

- 1** Crane 3 Lab Stabilizer
- 2** Handheld Tripod
- 3** Battery Charger
- 4** Cable Storage Case
- 5** Quick Setup Kits
- 6** Telescopic Monopod with Locking Buckle and Multifunctional Camera Belt
- 7** Phone Holder with Crown Gear
- 8** Miscellaneous
- 9** Batteries 18650
- 10** Focus and Zoom Combo Kits
- 11** Cable
- 12** Quick Release Base Plate
- 13** Quick Release Plate
- 14** HPRC1100 (not included)



HPRC ZHIYUN CRANE 3

## TECHNICAL FEATURES

### Dimension:

Internal dimension  
554,7x458,7x246(mm) - 21.84x18.06x9.69(in)

External dimension  
617,5x527,3x279,6(mm) - 24.31x20.76x11.0(in)

### Weight:

empty: 7,74kg - 17.06lbs  
with cubed foam: 8,84kg - 19.49lbs

### Temperature rating:

Minimum Maximum  
-40°C -40°F +80°C +176°F



## TECHNICAL DRAWING

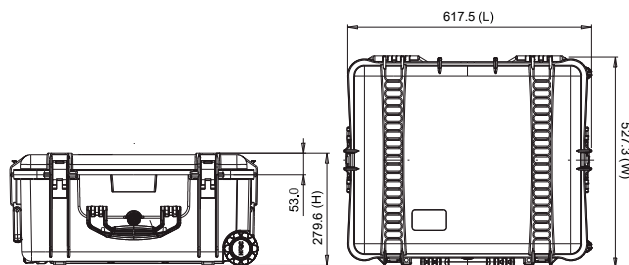

# HPRC2600W for Zhiyun Crane 3 Lab CR3-2600W-01



- 1** Crane 3 Lab Stabilizer
- 2** TransMount Handheld Tripod
- 3** Battery Charger
- 4** Batteries 18650
- 5** Cable Storage Case
- 6** Quick Release Plate
- 7** TransMount Phone Holder



HPRC ZHIYUN CRANE 3

## TECHNICAL FEATURES

### Dimension:

Internal dimension  
482,4x358,3x217,6(mm) - 18.99x14.1x8.57(in)

External dimension  
546,9x426,8x250,7(mm) - 21.53x16.8x9.87(in)

### Weight:

empty: 6,05kg - 13.34lbs  
with cubed foam: 6,97kg - 15.37lbs

### Temperature rating:

Minimum                      Maximum  
-40°C -40°F                      +80°C +176°F



## TECHNICAL DRAWING

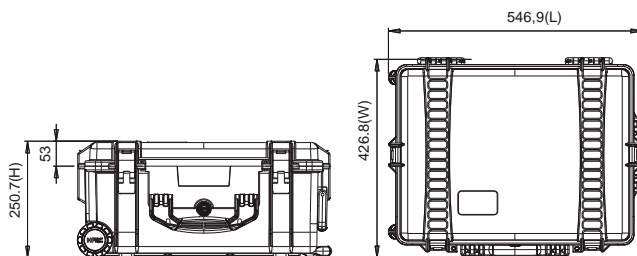





**Z CAM**

HPRC READY MADE SOLUTIONS – 2025

# HPRC2400 for Z Cam E2-F6 Full Frame 6K Cinema Camera ZE2F6-2400-01



- 1** Z Cam E2-F6 Full Frame 6K Cinema Camera with SmallRig Cage mounted
- 2** Alternative Lens Mount
- 3** Accessories
- 4** Charger
- 5** Cable
- 6** NF-P Battery
- 7** CFast 2.0
- 8** WiFi Antenna



HPRC Z CAM E2-F6

## TECHNICAL FEATURES

### Dimension:

Internal dimension  
377x263,9x150,8(mm) - 14.84x10.39x5.94(in)  
External dimension  
402x330,5x169,2(mm) - 15.83x13.01x6.66(in)

### Weight:

empty: 2,23kg - 4.91lbs  
with cubed foam: 2,49kg - 5.49lbs

### Temperature rating:

Minimum Maximum  
-40°C -40°F +80°C +176°F



## TECHNICAL DRAWING

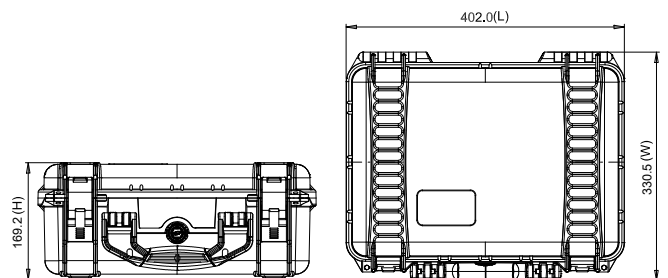



FUJIFILM  
HPRC

FUJIFILM



HPRC READY MADE SOLUTIONS - 2025



# HPRC2500 for Fujifilm GFX100

## GFX100-2500-01



- 1** Fujifilm GFX100
- 2** Cable storage/Miscellaneous
- 3** Adjustable lens: FUJIFILM GF 110mm f/2 R LM WR Lens, 23mm f/4 R LM WR Lens, 45mm f/2.8 R WR Lens, 32-64mm f/4 R LM WR Lens
- 4** Battery charger
- 5** Battery NP-T125
- 6** Ac Power Adapter



HPRC FUJIFILM GFX100

### TECHNICAL FEATURES

#### Dimension:

internal dimension  
449,8x322,9x174,9(mm) - 17.71x12.71x6.89(in)  
external dimension  
478,1x389,4x194(mm) - 18.82x15.33x7.64(in)



#### Weight:

empty: 3,22kg - 7.10lbs  
with cubed foam: 3,75kg - 8.27lbs

#### Temperature rating:

Minimum Maximum  
-40°C -40°F +80°C +176°F

### TECHNICAL DRAWING

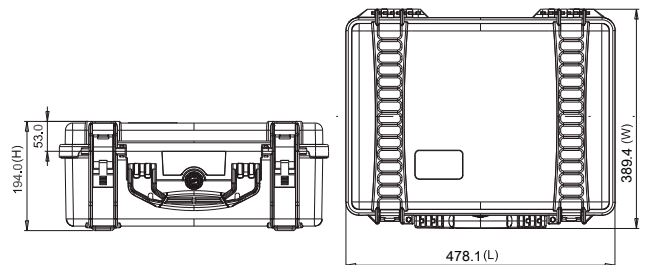



RED

HPRC READY MADE SOLUTIONS - 2025

# HPRC2730W for Red Ranger Gemini

## RGE-2730W-01

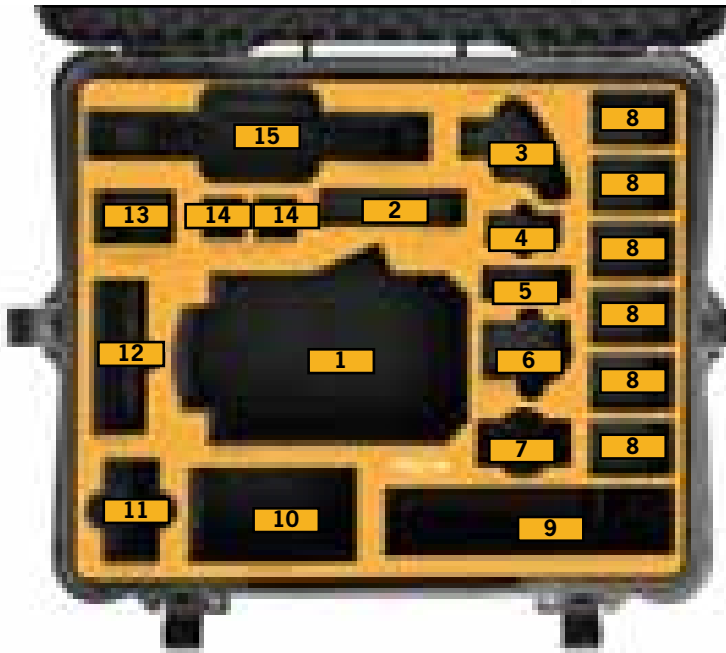

- 1** Camera with Top Handle
- 2** HPRC1300 MEVBLB
- 3** Right Side Wooden Handle 2.0 with R/S Button - Tilta
- 4** Red Mini Mag
- 5** Cable
- 6** Red Bomb EVF DSMC
- 7** Titan Support Arm with Single 1/4" QR Bracket – Monitor Side
- 8** GDU 98Wh Mini V-Lock Battery
- 9** Cable
- 10** BlueShape Travel Charger
- 11** Red Ranger Ac Power Adaptor
- 12** DSMC2 Red Touch 7.0" LCD
- 13** Smallrig for monitor LCD EVF Mount/BMVA/SmallHD, Zacuto Gratical HD1938
- 14** Smallrig Rosette Arm Handle for Shoulder Stabilizer
- 15** Quick Release Platform



HPRC RED RANGER GEMINI

### TECHNICAL FEATURES

#### Dimension:

internal dimension  
503x459x316(mm) - 19.80x18.07x12.44(in)  
external dimension  
616,9x531x349,6(mm) - 24.29x20.91x13.76(in)

#### Weight:

empty: 8,41kg - 18.54lbs  
with cubed foam: 10,43kg - 22.99lbs

#### Temperature rating:

Minimum Maximum  
-40°C -40°F +80°C +176°F



### TECHNICAL DRAWING

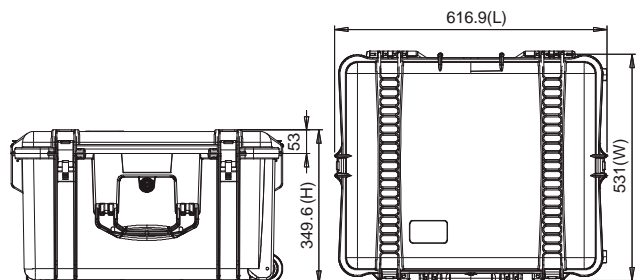



**NIKON**

HPRC READY MADE SOLUTIONS – 2025

# HPRC2460 for Nikon D850

## D850-2460-01



for **NIKON D850**



- 1** D850 Camera Body
- 2** Additional EN-EL15a Rechargeable Li-ion Battery
- 3** ME-W1 Wireless Microphone
- 4** ME-1 Stereo Microphone
- 5** Atomos Ninja Flame
- 6** Lenses: AF-S NIKKOR 35mm f/1,8G ED / AF-S NIKKOR 85mm f/1.8G / AF-S NIKKOR 20mm f/1,8G ED
- 7** MH-25A Battery Charger/ UC-E22 USB Cable / Coiled HDMI Cable

HPRC NIKON D850

### TECHNICAL FEATURES

**Dimension:**

internal dimension  
409x306x175(mm) - 16.1x12.05x6.89(in)  
external dimension  
435x377,8x193(mm) - 17.13x14.87x7.60(in)

**Weight:**

empty: 2,55kg - 5.62lbs  
with cubed foam: 3,14kg - 6.92lbs

**Temperature rating:**

Minimum            Maximum  
-40°C -40°F        +80°C +176°F



### TECHNICAL DRAWING

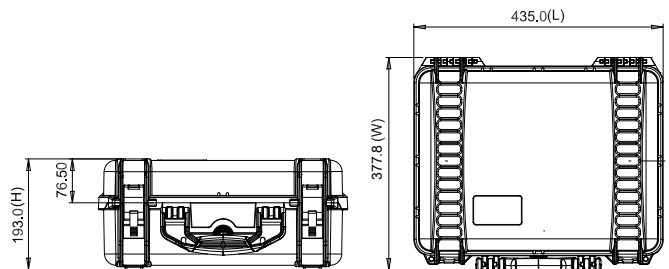



**PANASONIC**

HPRC READY MADE SOLUTIONS – 2025

# HPRC2460 for Panasonic GH5

## S-GH52460-01



HPRC2460 for PANASONIC GH5 is a special edition, designed to safely carry your GH5 Lumix G Series.

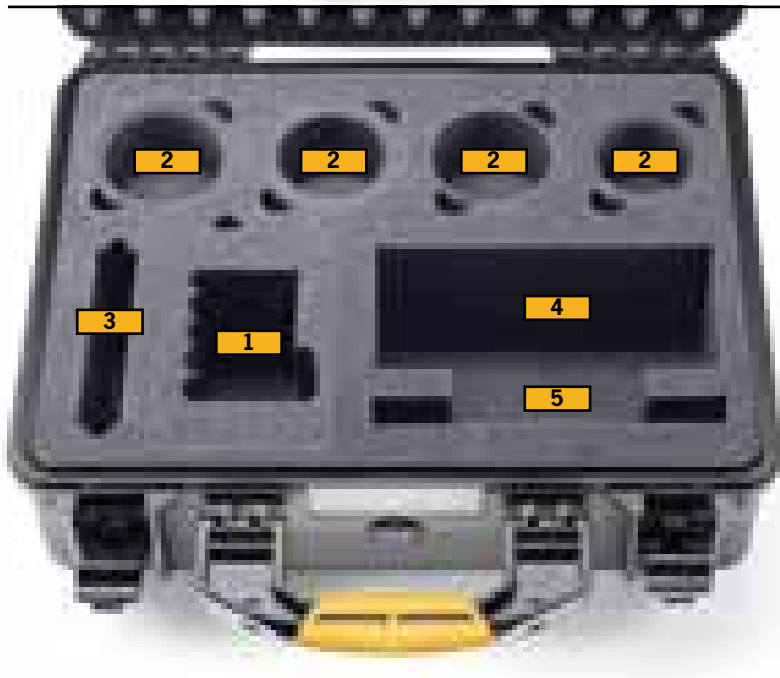

- 1** PANASONIC GH5 with or without professional cage and lenses mounted
- 2** Lenses: lumix g 8mm f3,5 (fisheye) hd, lumix dg summilux 12 f1.4, lumix g pancake 14mm f2.5, leica dg summilux 15mm /f1,7 asph, lumix g 20mm f1,7 (asph), leica dg summilux 25mm f1,4 (asph), lumix g 25mm f1.7 asph., lumix g 30mm macro f2,8, leica dg noctricron 42,5 mm f 1,2 (asph) hd, lumix g dg 1,7 / 42,5mm asph/power o.i.s., leica dg macro-elmarit 45mm f2,8 (asph), lumix g vario 7-14mm f4,0 (asph) hd, leica dg vario elmarit 8-18, lumix g vario 12-32mm f3,5-f5,6 (asph) hd, lumix g x vario 12-35mm f2,8 (asph) hd, lumix g x vario 12-35 ii, leica dg vario elmarit 12-60, lumix g vario 12-60, lumix g vario 14-42mm f3,5-5,6 (asph) hd, lumix g vario 14-42mm f3,5-5,6 (asph) hd, lumix g x vario pz 14-42mm f3,5-5,6 (asph), lumix g vario 14-42mm f3,5-5,6 (asph) hd, lumix g x vario pz 14-42mm f3,5-5,6 (asph), lumix g vario 14-45mm f3,5-5,6 (asph) hd, lumix g x vario 35-100mm f2,8 hd, lumix g x vario 35-100 ii, lumix g vario 35-100mm f4,0-5,6, lumix g vario 45-200 ii, lumix g 12,5mm f12,5 3d
- 3** Battery chargers, cables
- 4** Accessories (baseplate, rods, top grip handles, lockports, cables, batteries, controllers, GoPro)
- 5** External recorder Atomos/Sound Device etc

HPRC PANASONIC GH5

### TECHNICAL FEATURES

#### Dimension:

internal dimension  
409x306x175(mm) - 16.1x12.05x6.89(in)  
external dimension  
435x377,8x193(mm) - 17.13x14.87x7.60(in)

#### Weight:

empty: 2,55kg - 5.62lbs  
with cubed foam: 3,14kg - 6.92lbs

#### Temperature rating:

Minimum Maximum  
-40°C -40°F +80°C +176°F



### TECHNICAL DRAWING

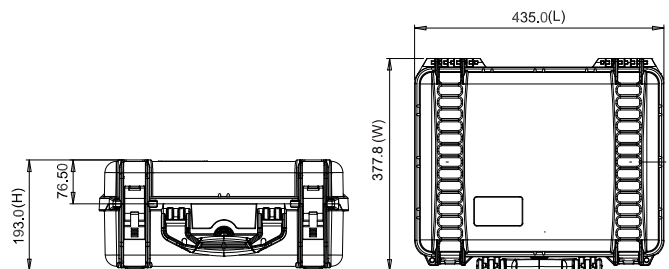



LEICA



LEICA

HPRC READY MADE SOLUTIONS - 2025



# HPRC2400 for Leica M

## LEM2400-01



FOR LEICA M

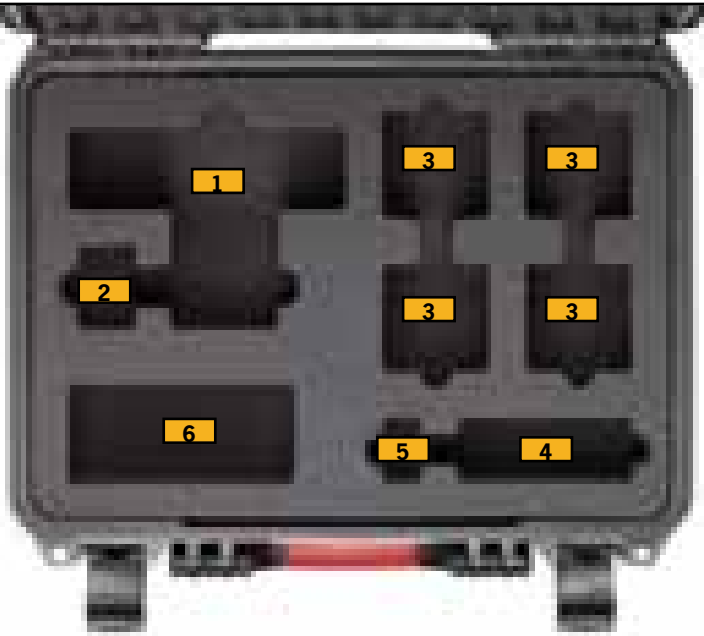

- 1** 1 x Leica M Camera Body with Lens Attached
- 2** Electronic Viewfinder
- 3** 4 x Lens
- 4** Charger
- 5** Spare Battery
- 6** Cables/Miscellaneous

HPRC LEICA M

### TECHNICAL FEATURES

**Dimension:**

Internal dimension  
377x263,9x150,8(mm) - 14,84x10,39x5,94(in)  
External dimension  
402X330,5X169,2(mm) - 15.83x13.01x6.66(in)

**Weight:**

empty: 2,38kg - 5.25lbs

**Temperature rating:**

Minimum Maximum  
-40°C -40°F +80°C +176°F



### TECHNICAL DRAWING

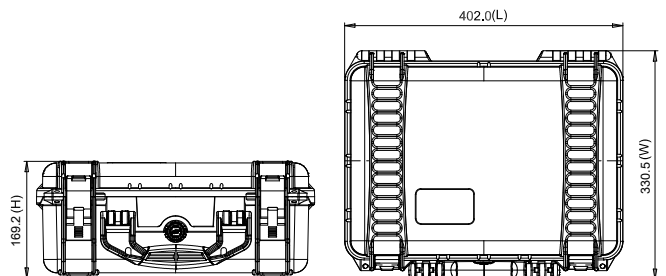

# HPRC2460 for Leica M LEM2460-01



FOR LEICA M



- 1** 2 x Leica M Camera Body with Lens Attached
- 2** 2 x Electronic Viewfinder
- 3** 2 x Spare Batteries
- 4** 4 x Lens
- 5** 2 x Charger
- 6** Cables/Miscellaneous



HPRC LEICA M

## TECHNICAL FEATURES

### Dimension:

internal dimension  
409x306x175(mm) - 16.1x12.05x6.89(in)  
external dimension  
435x377,8x193(mm) - 17.13x14.87x7.60(in)

### Weight:

empty: 2,55kg - 5.62lbs  
with cubed foam: 3,14kg - 6.92lbs

### Temperature rating:

Minimum Maximum  
-40°C -40°F +80°C +176°F



## TECHNICAL DRAWING

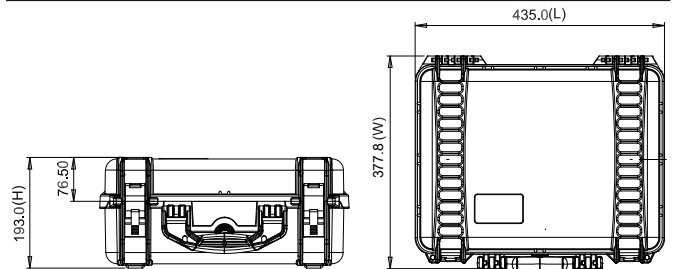



8  
11  
16  
MP  
20





APPLE



HPRC READY MADE SOLUTIONS - 2025

# HPRC2530 for Apple Mac Studio / Mac Mini

## STU-2530-01

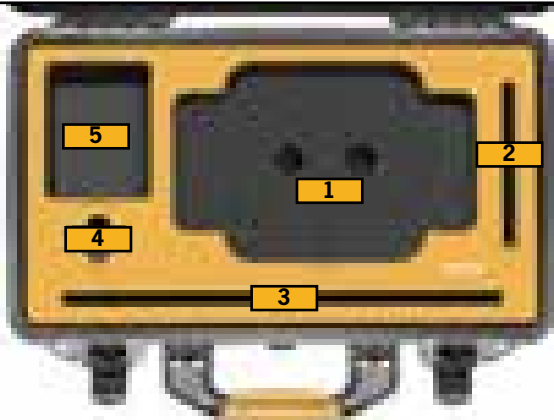

- 1** Mac Studio / Mac Mini
- 2** Magic Trackpad
- 3** Magic Keyboard
- 4** Magic Mouse
- 5** Cable/Miscellaneous



### MAC STUDIO LAYOUT

Just remove the additional foam **2** from the main slot **1**.  
The case is ready to house and protect your Mac Studio.



### MAC MINI LAYOUT

Keep the additional foam **2** in the main slot **1**.  
Your Mac Mini can be placed above. Safe and sound.



## TECHNICAL FEATURES

### Dimension:

Internal dimension:  
513x288x132(mm) - 20.20x11.34x5.20(in)

External dimension:  
540x350x153(mm) - 21.26x13.78x6.02(in)

### Weight:

empty: 3,20kg - 7,05lbs  
with cubed foam: 3,26kg - 7,19lbs

### Temperature rating:

Minimum Maximum  
-40°C -40°F +80°C +176°F



## TECHNICAL DRAWING

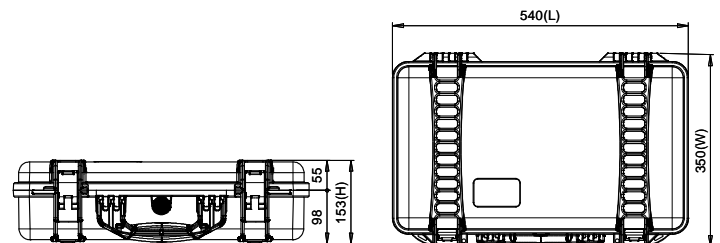

# HPRC2530 for MacBook Pro 16"

## MPRO-2530-01

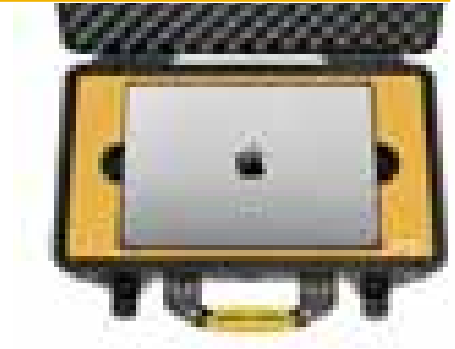

- 1** MacBook Pro 16"
- 2** Miscellaneous



HPRC APPLE MACBOOK PRO 16"

### TECHNICAL FEATURES

**Dimension:**

Internal dimension  
51.3x28.8x1.32(mm) - 20.20x11.34x0.52(in)  
External dimension  
540x350x153(mm) - 21.26x13.78x6.02(in)

**Weight:**

empty: 2,84kg - 6.26lbs  
with foam: 3,25kg - 7.16lbs

**Temperature rating:**

Minimum                      Maximum  
-40°C -40°F                      +80°C +176°F



### TECHNICAL DRAWING

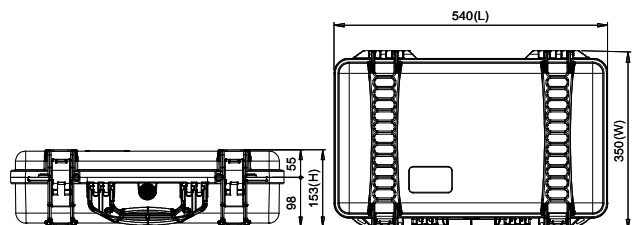

# HPRC4800W for Apple Mac Pro

## MPRO-4800W-01

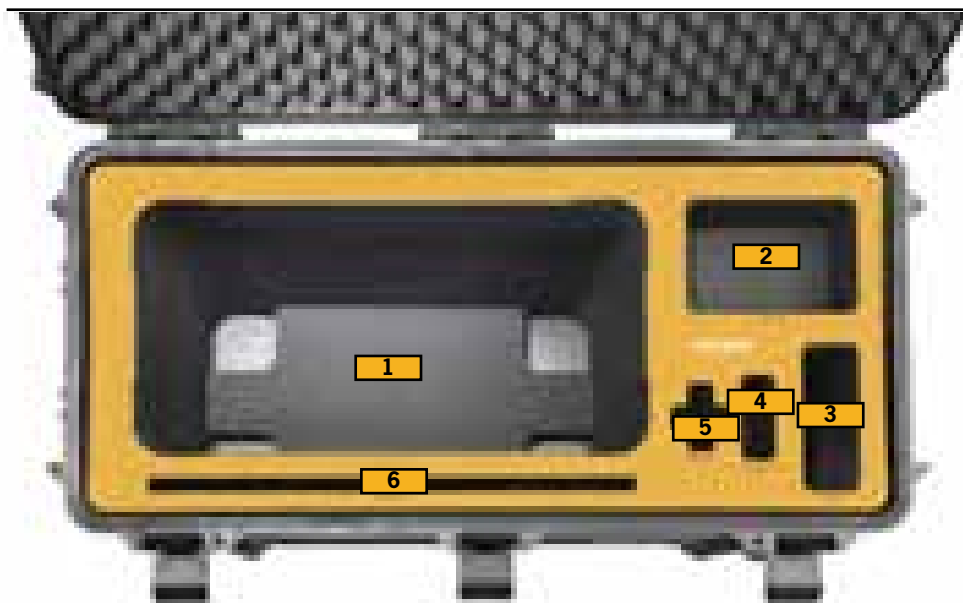

- 1** Mac Pro
- 2** Miscellaneous
- 3** Power cord
- 4** USB-C to Lightning Cable
- 5** Magic Mouse 2
- 6** Magic Keyboard



HPRC APPLE MAC PRO

### TECHNICAL FEATURES

#### Dimension:

internal dimension  
720x320x600(mm) - 28.34x12.60x23.62(in)  
external dimension  
776x380x649(mm) - 30.55x14.96x25.55(in)

#### Weight:

empty: 10,00kg - 22.21lbs  
with cubed foam: 14,10kg - 31.08lbs

#### Temperature rating:

Minimum Maximum  
-40°C -40°F +80°C +176°F



### TECHNICAL DRAWING

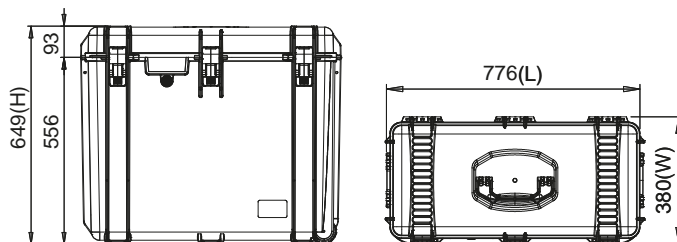

# HPRC2400 for MacPro15"

## MPRO-2400-01

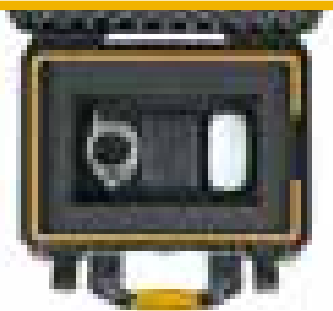

- 1** MacBook Pro 15"
- 2** Miscellaneous



HPRC APPLE MACPRO 15"

### TECHNICAL FEATURES

**Dimension:**

Internal dimension  
377x263,9x150,8(mm) - 14.84x10.39x5.94(in)  
External dimension  
402x330,5x169,2(mm) - 15.83x13.01x6.66(in)

**Weight:**

empty: 2,38kg - 5.25lbs

**Temperature rating:**

Minimum            Maximum  
-40°C -40°F        +80°C +176°F



### TECHNICAL DRAWING

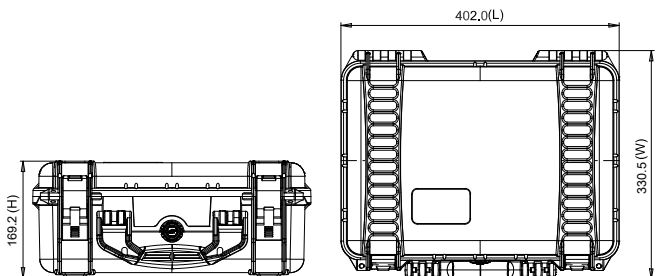







EIZO

HPC READY MADE SOLUTIONS - 2025

# HPRC4800W for Eizo 27/24" EIZ27-4800W-01

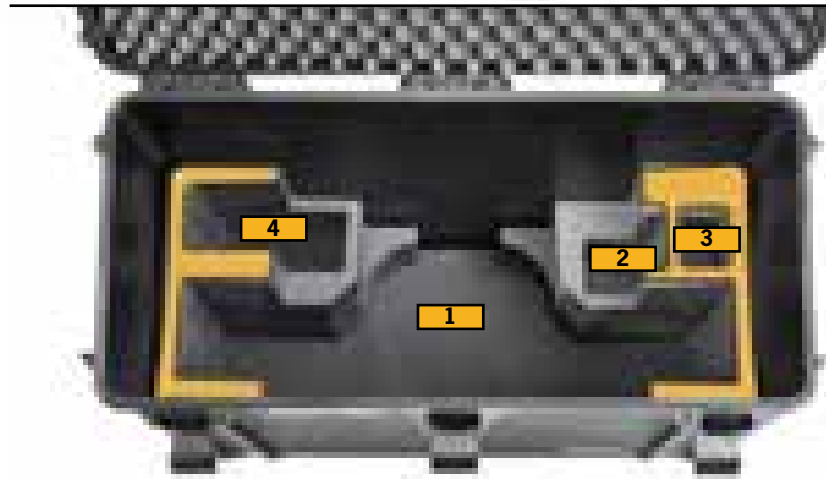

- 1** Eizo Monitor 27" or 24"
- 2** Cables and accessories
- 3** Cables and accessories
- 4** Protective hood and accessories



HPRC EIZO 27/24"

## TECHNICAL FEATURES

### Dimension:

internal dimension  
720x320x600(mm) - 28.34x12.60x23.62(in)  
external dimension  
776x380x649(mm) - 30.55x14.96x25.55(in)

### Weight:

empty: 11,12kg - 24.50lbs  
with cubed foam: 12,43kg - 27.40lbs

### Temperature rating:

Minimum Maximum  
-40°C -40°F +80°C +176°F



## TECHNICAL DRAWING

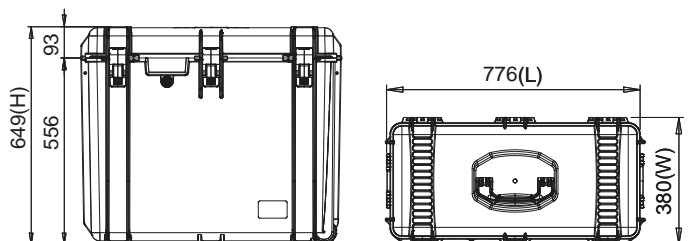



## UNIVERSAL MICROPHONES

HPRC READY MADE SOLUTIONS – 2025

# HPRC2200 for 3 Universal Microphones

## MCF3-2200-01

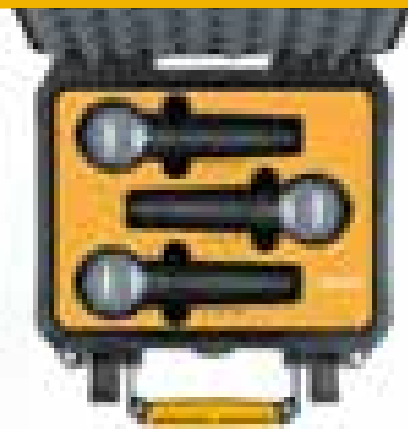

**1** Universal Microphone



### TECHNICAL FEATURES

**Dimension:**

internal dimension  
236x182x108(mm) - 9.29x7.17x4.25(in)  
external dimension  
258x244,3x123,3(mm) - 10.16x9.62x4.85(in)

**Weight:**

empty: 0,87kg - 1.92lbs  
with cubed foam: 1,08kg - 2.38lbs

**Temperature rating:**

Minimum Maximum  
-40°C -40°F +80°C +176°F



### TECHNICAL DRAWING

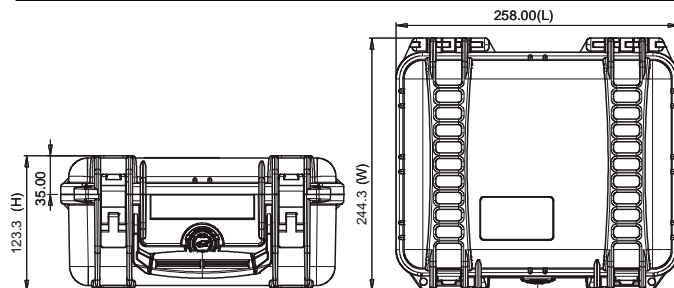

# HPRC2250 for 6 Universal Microphones

## MCF6-2250-01



LEVEL 1

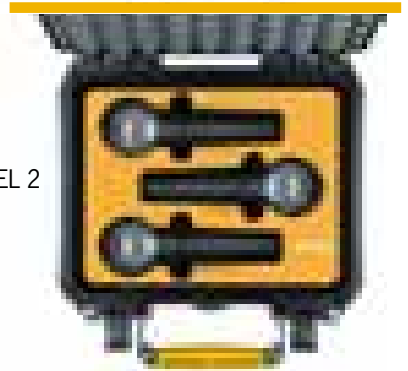

LEVEL 2

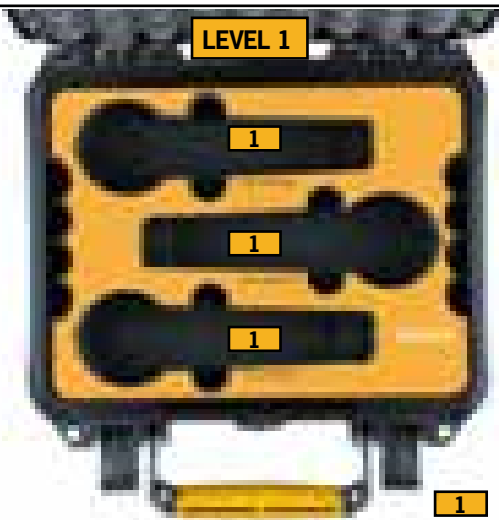

LEVEL 1

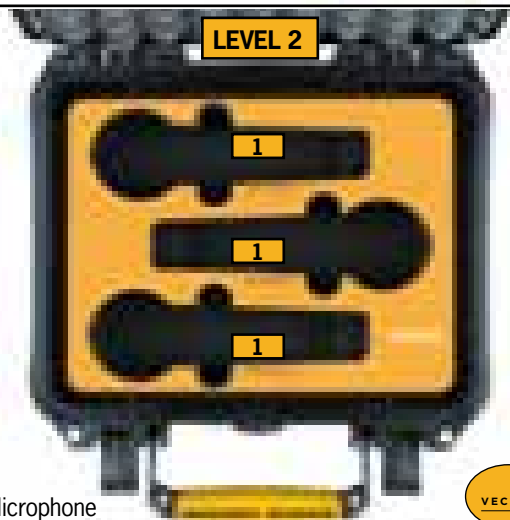

LEVEL 2

1 Universal Microphone



HPRC MICROPHONES

### TECHNICAL FEATURES

**Dimension:**

internal dimension  
236x182x155(mm) - 9.29x7.17x6.10(in)  
external dimension  
258X230X170(mm) - 10.16x9.06x6.69(in)

**Weight:**

empty: 1,00kg - 2.20lbs  
with cubed foam: 1,35kg - 2.97lbs

**Temperature rating:**

Minimum Maximum  
-40°C -40°F +80°C +176°F



### TECHNICAL DRAWING

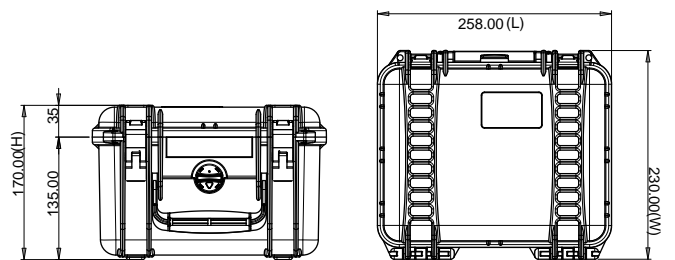



I



BROMPTON

BROMPTON

HPRC READY MADE SOLUTIONS – 2025



# HPRC4800W for Brompton BRO4800W-01

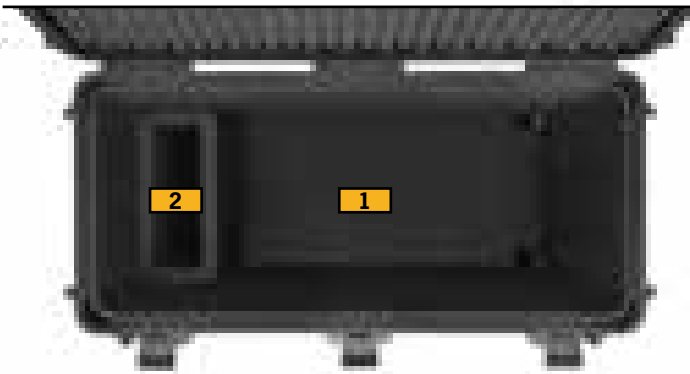

**1** Brompton Bike

**2** Accessories



HPRC BROMPTON

## TECHNICAL FEATURES

### Dimension:

internal dimension  
720x320x600(mm) - 28.34x12.60x23.62(in)  
external dimension  
776x380x649(mm) - 30.55x14.96x25.55(in)

### Weight:

empty: 10,00kg - 22.21lbs  
with foam: 11,60kg - 25.57lbs

### Temperature rating:

Minimum Maximum  
-40°C -40°F +80°C +176°F



## TECHNICAL DRAWING

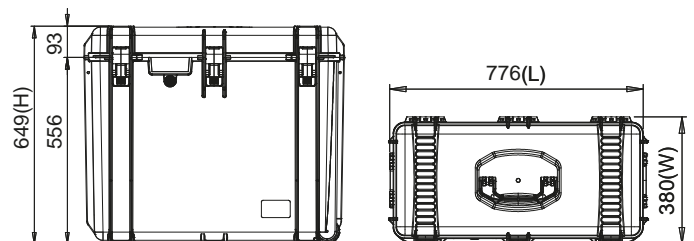

code	description	page
	<b>DJI</b>	<b>4</b>
<b>S-MAV3P-2400-02</b>	HPRC2400 FOR DJI MAVIC 3 PRO CINE PREMIUM COMBO / FLY MORE COMBO	5
<b>S-MAV3PFM-2600-01</b>	HPRC2600 FOR DJI MAVIC3 PRO CINE PREMIUM COMBO FLYING MODE & DJI MINI 4 PRO FLY MORE COMBO	6
<b>S-MAV3P-3500-01</b>	HPRC3500 FOR DJI MAVIC 3 PRO CINE PREMIUM COMBO / FLY MORE COMBO	7
<b>S-MAV3PBAG35</b>	HPRC SOFT BAG FOR DJI MAVIC 3 PRO CINE PREMIUM COMBO / FLY MORE COMBO	8
<b>MAV3-2400-01</b>	HPRC2400 FOR DJI MAVIC3 CINE OR DJI MAVIC3	9
<b>MAV3-3500-01</b>	HPRC3500 FOR DJI MAVIC3 CINE OR DJI MAVIC3	10
<b>MAVBAG35-05</b>	HPRC SOFT BAG WITH FOAM FOR DJI MAVIC3 CINE OR DJI MAVIC3	11
<b>S-M350-2800W-03</b>	HPRC FOR DJI MATRICE 350 RTK (ZENMUSE H30/H30T VERSION)	12
<b>S-M300-2800W-04</b>	HPRC FOR DJI MATRICE 300 RTK (ZENMUSE H30/H30T VERSION)	13
<b>BAT2550W-04</b>	HPRC2550W BATTERY CASE FOR DJI MATRICE 300/350	14
<b>DRTK6500W-01</b>	HPRC6500W FOR DJI D-RTK2	15
<b>S-M3TD-2710-01</b>	HPRC2710 FOR DJI MATRICE 3D/3TD	16
<b>M30T-5200R-01</b>	HPRC5200R FOR DJI MATRICE 30T	17
<b>M30T-2760W-01</b>	HPRC2760W FOR DJI MATRICE 30T	18
<b>M30T-2700W-01</b>	HPRC2700W FOR DJI MATRICE 30T	19
<b>BAT2460-01</b>	HPRC2460 FOR BATTERIES TB30 AND DJI RC PLUS	20
<b>S-RCP-2500-01</b>	HPRC2500 FOR DJI RC PLUS CONTROLLERS AND WB37 BATTERIES	21
<b>S-INS3-2800W-01</b>	HPRC2800W FOR DJI INSPIRE 3	22
<b>S-BAT2550W-05</b>	HPRC2550W FOR INSPIRE 3 BATTERIES	23
<b>S-MAVM-2300-04</b>	HPRC2300 FOR DJI MINI 4 PRO FLY MORE COMBO WITH SMART CONTROLLER	24
<b>S-NEO-2300-01</b>	HPRC2300 FOR DJI NEO FLY MORE COMBO	25
<b>S-MAV3A-2400-02</b>	HPRC2400 FOR DJI AIR 3 /AIR 3S FLY MORE COMBO	27
<b>S-MAV3A-3500-01</b>	HPRC3500 FOR DJI AIR 3 /AIR 3S FLY MORE COMBO	28
<b>S-AVAT2-2500-01</b>	HPRC2500 FOR DJI AVATA 2 FLY MORE COMBO	29
<b>S-AVAT2-3500-01</b>	HPRC3500 FOR DJI AVATA 2 FLY MORE COMBO	30
<b>AVAT-2500-01</b>	HPRC2500 FOR DJI AVATA PRO - VIEW COMBO	31
<b>AVAT-3500-01</b>	HPRC3500 FOR DJI AVATA PRO - VIEW COMBO	32
<b>FPV-2500-01</b>	HPRC2500 FOR DJI FPV COMBO	33
<b>FPV-3600-01</b>	HPRC3600 FOR DJI FPV COMBO	34
<b>PHA4RTK-2700W-01</b>	HPRC2700W FOR DJI PHANTOM 4RTK / MULTISPECTRAL	35
<b>R4D-2730W-01</b>	HPRC2730W FOR DJI RONIN 4D-6K COMBO	36
<b>S-RS4-2600-01</b>	HPRC2600 FOR DJI RS 4 PRO COMBO	37
<b>RS3-2600-01</b>	HPRC2600 FOR DJI RS 3 PRO COMBO	38
<b>RS3M-2300-01</b>	HPRC2300 FOR DJI RS 3 MINI CREATOR COMBO	39
<b>OSMPKT-1400-02</b>	HPRC1400 FOR DJI POCKET 2 CREATIVE COMBO KIT	40
<b>S-OSMPKT-1400-03</b>	HPRC1400 FOR DJI OSMO POCKET 3 CREATOR COMBO	41
	<b>AUTEL ROBOTICS</b>	<b>42</b>
<b>LITE-2460-01</b>	HPRC2460 FOR AUTEL ROBOTICS EVO LITE + PREMIUM BUNDLE	43
<b>NANO-2300-01</b>	HPRC2300 FOR AUTEL ROBOTICS EVO NANO + PREMIUM BUNDLE	44
<b>EVO2-2400-02</b>	HPRC2400 FOR AUTEL ROBOTICS EVO II 6K / 8K DRONE - REV. 02	45

code	description	page
<b>ATOMOS</b>		<b>46</b>
NJAV-2300-01	HPRC2300 FOR ATOMOS NINJA ULTRA, NINJA OR NINJA V	47
S-SHGC-2400-01	HPRC2400 FOR ATOMOS SHOGUN, SHOGUN ULTRA AND SHOGUN CONNECT	48
SM19-2730W-01	HPRC2730W FOR ATOMOS SUMO 19"	49
<b>BLACKMAGIC</b>		<b>50</b>
PKT6P-2400-01	HPRC2400 FOR BLACKMAGIC POCKET CINEMA CAMERA 6K PRO OR BLACKMAGIC CINEMA CAMERA 6K	51
PKTC-2400-01	HPRC2400 COMBO FOR BLACKMAGIC POCKET CINEMA CAMERA 6K OR 4K + METABONES	52
S-BMS-5200-01	HPRC5200 FOR BLACKMAGIC STUDIO CAMERA 6K PRO/4K PRO G2/4K PLUS	53
S-ATS-2760W-01	HPRC2760W FOR BLACKMAGIC DESIGN ATEM TELEVISION STUDIO 4K8 /HD8 /HD8 ISO + ATEM MICROPHONE CONVERTER	54
S-ACCP-2710-01	HPRC2710 FOR BLACKMAGIC DESIGN ATEM CAMERA CONTROL PANEL	55
AMI-2300-01	HPRC2300 FOR ATEM MINI, ATEM MINI PRO AND ATEM MINI PRO ISO	56
AME-2500-01	HPRC2500 FOR ATEM MINI EXTREME AND ATEM MINI EXTREME ISO	57
ADV1-2710-01	HPRC2710 FOR BLACKMAGIC DESIGN ATEM 1 M/E ADVANCED PANEL	58
URS2730W-03	HPRC2730W FOR BLACKMAGIC URSA MINI PRO - URSA BROADCAST	59
<b>SONY</b>		<b>60</b>
ALP2460-01	HPRC2460 SPECIAL EDITION FOR SONY ALPHA 7	61
FX3-2400-01	HPRC2400 FOR SONY FX3 CINEMA LINE	62
FX6-2550W-01	HPRC2550W PER SONY ILME-FX6 CINEMA LINE	63
FX9-2700W-01	HPRC2700W FOR SONY PXW-FX9 - CINEMA LINE	64
S-BRN-2700W-01	HPRC2700W FOR SONY BURANO 8K CAMERA - CINEMA LINE	65
S-FR7-4400-01	HPRC4400 FOR SONY ILME - FR7	66
S-IP500-2460-01	HPRC2460 FOR SONY IP500 PTZ CAMERA REMOTE CONTROLLER	67
Z280-2600W-01	HPRC2600W FOR SONY PXW-Z280	68
Z190-2700W-01	HPRC2700W FOR SONY PXWZ190V	69
<b>CANON</b>		<b>70</b>
CR5-2300-01	HPRC2300 FOR CANON EOS R5 / R6	71
C300-2700W-01	HPRC2700W FOR CANON EOS C300 MARK III	72
C70-2600-01	HPRC2600 FOR CANON EOS C70	73
C200-2600-01	HPRC2600 FOR CANON EOS C200	74
C100-2600-01	HPRC2600 FOR CANON EOS C100	75
<b>MOZA</b>		<b>76</b>
MAIR2-2530-01	HPRC2530 FOR MOZA AIR2 IFOCUS	77
<b>ZHIYUN CRANE</b>		<b>78</b>
CR3-2700W-01	HPRC2700W FOR ZHIYUN CRANE 3 LAB MASTER PACKAGE	79
CR3-2600W-01	HPRC2600W FOR ZHIYUN CRANE 3 LAB	80
<b>Z CAM</b>		<b>82</b>
ZE2F6-2400-01	HPRC2400 FOR Z CAM E2-F6 FULL FRAME 6K CINEMA CAMERA	83

# Index

code	description	page
	<b>FUJIFILM</b>	<b>84</b>
<b>GFX100-2500-01</b>	HPRC2500 FOR FUJIFILM GFX100	85
	<b>RED</b>	<b>86</b>
<b>RGE-2730W-01</b>	HPRC2730W FOR RED RANGER GEMINI	87
	<b>NIKON</b>	<b>88</b>
<b>D850-2460-01</b>	HPRC2460 FOR NIKON D850 FILMMAKER'S KIT	89
	<b>PANASONIC</b>	<b>90</b>
<b>S-GH52460-01</b>	HPRC2460 SPECIAL EDITION FOR PANASONIC GH5 AND ACCESSORIES	91
	<b>LEICA</b>	<b>92</b>
<b>LEM2400-01</b>	HPRC2400 FOR LEICA M	93
<b>LEM2460-01</b>	HPRC2460 FOR LEICA M	94
	<b>APPLE</b>	<b>96</b>
<b>STU-2530-01</b>	HPRC2530 FOR APPLE MAC STUDIO / MAC MINI	97
<b>MPRO-2530-01</b>	HPRC2530 FOR MACBOOK PRO 16"	98
<b>MPRO-4800W-01</b>	HPRC4800W FOR APPLE MACPRO 2020	99
<b>MPRO-2400-01</b>	HPRC2400 FOR APPLE MACBOOK PRO 15"	100
	<b>EIZO</b>	<b>102</b>
<b>EIZ27-4800W-01</b>	HPRC4800W FOR EIZO MONITOR 27" AND EIZO MONITOR 24"	103
	<b>UNIVERSAL MICROPHONES</b>	<b>104</b>
<b>MCF3-2200-01</b>	HPRC2200 FOR 3 UNIVERSAL MICROPHONES	105
<b>MCF6-2250-01</b>	HPRC2250 FOR 6 UNIVERSAL MICROPHONES	106
	<b>BROMPTON</b>	<b>108</b>
<b>BRO4800W-01</b>	HPRC4800W FOR BROMPTON FOLDING BIKE	109

READY









**Plaber S.r.l. - HPRC cases**

Via Div. Tridentina, 10  
36061 Bassano del Grappa  
Vicenza - Italy

Tel. +39 0424 809150

USA office and warehouse:

**Plaber America Inc - HPRC cases**

110 Chestnut Ridge Rd. #314  
Montvale, NJ 07645

Tel. +1 (201) 989 3353

[www.hprc.it](http://www.hprc.it) | [www.hprcusa.com](http://www.hprcusa.com)

[info@hprc.it](mailto:info@hprc.it)

HPRC® Brand owned by:

*plaber*

HPRC READY MADE SOLUTIONS — 2025